

LokPilot V3.0

Users manual

6. edition, July 2008

LokPilot V3.0

LokPilot V3.0 DCC

LokPilot V3.0 mfx

LokPilot XL V3.0

LokPilot micro V3.0

LokPilot micro V3.0 DCC

LokPilot Fx V3.0



Lok Pilot®

P/N 51978



Contents

1. Declaration of conformity	4	6.6. Locomotives without Interface	12
2. WEEE-Declaration (Europe only)	4	6.6.1. Wiring Diagram for LokPilot or LokPilot micro	13
3. Important Notes – Please read this chapter first	5	6.6.2. Wiring Diagram for a LokPilot XL Decoder	14
4. How this manual helps you	6	6.6.3. Colour Coding by Märklin®	15
5. Introduction – The LokPilot Family	6	6.6.4. Motor and Track Connections	15
5.1. The Members of the LokPilot Family	6	6.6.4.1. Connecting DC and Coreless Motors	15
5.1.1. LokPilot V3.0 Decoders – an Overview	7	6.6.4.2. Connecting Universal Motors	16
5.1.2. LokPilot V3.0	7	6.7. Connecting Functions	16
5.1.3. LokPilot V3.0 DCC	7	6.7.1. Overload Protection of Function Outputs	16
5.1.4. LokPilot V3.0 mfx	8	6.7.1.1. Suitable Light Bulbs	16
5.1.5. LokPilot XL V3.0	8	6.7.2. Connecting the Light Outputs, AUX1 and AUX2	16
5.1.6. LokPilot micro V3.0	8	6.7.3. Purpose of AUX3 and AUX4	17
5.1.7. LokPilot micro V3.0 DCC	8	6.7.3.1. LokPilot with 21MTC Interface	17
5.1.8. LokPilot Fx V3.0	8	6.7.3.2. LokPilot Fx V3.0	17
5.2. General Properties of all Decoders	8	6.7.4. Suitable Smoke Generators	17
5.2.1. Operating Modes	8	6.8. Connecting Capacitors	18
5.2.2. Motor Control	8	6.8.1. All LokPilot HO	18
5.2.3. Analogue Mode	9	6.8.2. Integral „PowerPack“ in LokPilot XL V3.0	18
5.2.4. Functions	9	7. Initial Operation	19
5.2.5. Programming	9	7.1. Factory Default Values	19
5.2.6. Operational Reliability	9	7.2. Digital Operating Modes	20
5.2.7. Protection	9	7.2.1. DCC Mode	20
5.2.8. Future included	9	7.2.1.1. DCC Speed Steps („flashing lights“)	20
6. Installing the Decoder	10	7.2.1.2. Auto-detection of DCC Speed Steps	20
6.1. Requirements for Installation	10	7.2.2. Motorola® Mode	21
6.2. Installing the Decoder	10	7.2.2.1. 28 Speed Steps	21
6.3. Locomotives with 8-pole NEM 652-Interface	10	7.2.2.2. Extended Motorola® Address Range	21
6.4. Locomotives with 6-pole NEM 651-Interface	11	7.2.3. Selectrix® Mode	21
6.5. Locomotives with 21MTC Interface	12	7.2.4. mfx® Mode	21
6.5.1. Connecting C-Sine motors („SoftDrive-Sinus“)	12	7.3. Analogue Mode	22
		7.3.1. Analogue DC operation	22
		7.3.2. Analogue AC Operation	22

8. Decoder Settings (Programming)	22	10.5. Brake Sectors	32
8.1. Adjustable Properties of Decoders	22	10.5.1. DC Brake Mode	32
8.1.1. Configuration Variables (CVs)	23	10.5.2. Märklin® Brake Mode	32
8.1.1.1. Standardisation in the NMRA	23	10.5.3. Selectrix® Diode Brake Sector	33
8.1.1.2. Bits and Bytes	23	10.6. Constant Brake Distance	33
8.1.2. mfx Configuration Range	24	10.7. Settings for Analogue Operation	33
8.2. Programming with popular Digital Systems	24	10.7.1. DC Analogue Operation	34
8.2.1. Programming with DCC Systems	24	10.7.2. AC Analogue Operation	34
8.2.2. Programming with the ESU ECoS	25	11. Motor Control	34
8.2.3. Programming with Märklin® 6021	25	11.1. Adjusting Load Compensation	34
8.2.3.1. Changing the Programming Mode	26	11.1.1. Parameter for frequently used Motors	34
8.2.3.2. The Short Mode	26	11.1.2. Adjustments for other Motors / „Fine Tuning“	35
8.2.3.3. Long mode	26	11.1.2.1. Parameter „K“	35
8.2.4. Programming with the Märklin® Mobile Station®	27	11.1.2.2. Parameter „I“	36
8.2.5. Programming with the Märklin® Central Station	27	11.1.2.3. Reference Voltage	36
8.2.6. Programming with the ESU LokProgrammer	28	11.2. Turning off Load Compensation	36
9. Address Settings	28	11.3. Adapting Load Control Frequency	36
9.1. Short Addresses in DCC Mode	28	11.4. Dynamic Drive Control: Up and Down the Hill	37
9.2. Long Addresses in DCC Mode	28	11.5. Settings for the C-Sinus Motor	37
9.3. Motorola® Address	29	12. Function outputs	38
9.4. Addresses in the mfx® Mode	29	12.1. Physical function outputs	38
10. Adapting the Driving Characteristics	29	12.2. Allocation of Function Buttons (Function Mapping)	38
10.1. Acceleration and Deceleration	29	12.3. Special Effects on Function Outputs	38
10.1.1. Switching Acceleration / Deceleration	29	12.3.1. Switching on Outputs and Different Options	38
10.1.2. Shunting Mode	30	12.3.2. Adjust Lamp Brightness	39
10.2. Starting Voltage, Maximum and Medium Speed	30	12.3.3. Digital Couplers	39
10.3. Speed Curve	30	12.3.3.1. „Pulse“ Mode for Telex®	39
10.4. Changing between Operating Modes	31	12.3.3.2. „Coupler“ Mode for Krois® and ROCO®	39
10.4.1. From Digital to Analogue DC	31	12.3.4. Blinker lights	39
10.4.2. From Digital to Analogue AC	31	12.3.4.1. Period for Blinker Lights	39
10.4.3. From Analogue to Digital (directional bit)	31	12.3.5. Examples for Typical Settings	42
10.4.4. From Digital to Digital	31	12.4. Analogue Settings	42
10.4.5. Changing modes with Analogue Mode turned off	32	12.5. LGB® Pulse Sequence Mode	43

12.6. Swiss Headlight Mode	43
13. Decoder Reset	43
13.1. With DCC Systems or 6020/6021	43
13.2. With Märklin® systems (mfx-decoder)	43
13.3. With the ESU LokProgrammer	43
14. Special Functions	44
14.1. Directional Bit	44
14.2. Saving the Operating Status	44
15. Multiple traction with LokSound Locomotives	44
16. RailCom®	45
17. Firmware Update	45
18. Accessories	46
18.1. Switching the Centre pick-up	46
18.2. HAMO Magnets	46
18.3. Wire Harnesses with 8-pole or 6-pole Socket	46
18.5. Mounting Adapter 21MTC	46
19. Support and assistance	46
20. Technical Data	47
21. List of all supported CVs	48
21.1. DCC Decoders	47
21.2. mfx-Decoder	68
22. Appendix	70
22.1. How to programm long addresses	70
23. Warranty	71

1. Declaration of conformity

We, ESU electronic solutions ulm GmbH & Co KG, Industriestraße 5, D-89081 Ulm, declare in sole responsibility that the products to which this declaration refers, namely

LokPilot V3.0, LokPilot V3.0 DCC, LokPilot V3.0 mfx, LokPilot micro V3.0, LokPilot micro V3.0 DCC, LokPilot XL V3.0, LokPilot Fx V3.0,

are in compliance with the following standards:

EN 71 1-3: 1988 / 6: 1994 – EN 50088: 1996 – EN 55014, part 1 + part 2: 1993

EN 61000-3-2: 1995 – EN 60742: 1995 – EN 61558-2-7: 1998 according to the directive

88 / 378 / EWG – 89 / 336 / EWG – 73 / 23 / EWG

2. WEEE-Declaration (Europe only)

Disposal of obsolete electrical and electronic equipment (as practised in the European Union and other European countries with dedicated collection systems).

This mark on the product, the packaging or the relevant documentation indicates that this product must not be treated like household waste. Instead this product should be disposed of at a suitable collection point for recycling of electrical and electronic appliances. Thus you contribute to avoid negative impact on the environment and people's health that could be caused by inappropriate disposal. Recycling of materials contributes to preserve our natural resources. For more information regarding recycling of this product, please contact your local administration, your waste collection service or the dealer / shop where you purchased this product.



3. Important Notes – Please read this chapter first

We congratulate you to your purchase of an ESU LokPilot decoder. This manual will guide you step by step through the features of your LokPilot decoder.

Please read this manual carefully. Although the LokPilot has been design as a robust device an incorrect connection may lead to faults or even to the destruction of the device. Avoid any “costly” experiments.

Copyright 1998 - 2007 by ESU electronic solutions ulm GmbH & Co KG. Electrical characteristics and dimensions are subject to change without prior notice. All rights reserved. ESU might not be held responsible for any damage or consequential loss or damage caused by inappropriate use of the product, abnormal operating conditions, unauthorized modifications to the products etc...Not suitable for children under 14 years of age. Inappropriate use may result in injury due to sharp points and edges. Märklin® is a registered trademark of the company Gebr.Märklin® and Cie. GmbH, Göppingen, Germany. RailCom is a registered trademark of the company Lenz Elektronik GmbH, Giessen, Germany. Alle anderen Warenzeichen sind Eigentum ihrer jeweiligen Rechteinhaber. ESU electronic solutions ulm GmbH & Co. KG entwickelt entsprechend seiner Politik die Produkte ständig weiter. ESU behält sich deshalb das Recht vor, ohne vorherige Ankündigung an jedem der in der Dokumentation beschriebenen Produkte Änderungen und Verbesserungen vorzunehmen. Vervielfältigungen und Reproduktionen dieser Dokumentation in jeglicher Form bedürfen der vorherigen schriftlichen Genehmigung durch ESU.



- The LokPilot is exclusively intended for use with model train layouts only. It may only be operated with the components listed here. Any other use is not permitted.
- Any wiring has to be carried out while power is disconnected.
- Avoid mechanical force or pressure on the decoder
- Do not remove the heat shrink sleeve on the decoder
- Make sure that neither the LokPilot decoder nor any blank wire ends may come into contact with the engine chassis (risk of short circuit). Cover any blank ends of unused wires.
- Never solder on the circuit board, extend cables if necessary
- Never wrap the decoder in insulation tape, since this may cause overheating
- Adhere to the wiring principles as outlined in this manual for wiring any external components. Other circuitry may cause damage to the LokPilot .
- Make sure that no wires are squeezed or cut by the model's transmission parts when reassembling the engine
- Any power supply must be protected by a fuse or circuit breaker to avoid any potential hazards such as burning cables in case of a short circuit. Only use transformers specifically designed for model trains that bear the VDE/EN marks.
- Never operate the LokPilot unattended. The LokPilot is not a (children's) toy.
- Do not expose to wet and humid conditions

How this manual helps you

4. How this manual helps you

This manual is divided into several chapters that show you step-by-step how to install a LokPilot decoder.

Chapter 5 provides an overview over the characteristics of each type of LokPilot decoder.

Chapter 6 describes installation of the decoder in detail. Please make yourself familiar with the type of motor and the type of interface installed in your locomotive prior to working through chapters 6.2. to 6.5.

You can operate LokPilot Decoders with most commercially available control systems for model trains. Chapter 7 provides an overview which digital and analogue systems can drive LokPilot decoders and which special issues to consider.

i You will find the factory default settings for the function buttons in chapter 7.1.

You may adjust the default settings of your LokPilot decoder as desired. Chapters 8 to 16 explain which parameters are adjustable and how to do it.

! We recommend, that you at least read chapters 8 and 9 regarding address settings as well as chapter 11 concerning motor control in order to be able to adapt your LokPilot decoder optimally to your model locomotive.

Chapter 20 lists all technical data as well as supported CVs and will assist you in case of questions.

! If not stated otherwise all information refers to all types of the LokPilot family. Should one particular decoder not support a specific function, then this is clearly mentioned.

5. Introduction – The LokPilot Family

5.1. The Members of the LokPilot Family

Once more ESU introduced an even more advanced version of the popular LokPilot decoder with its third generation LP (V3.0).

All LokPilot V3.0 decoders complement the excellent properties of their predecessors and expand their capabilities by further functions. These developments further improve the driving characteristics, the operational reliability, and the flexibility of the decoders.

The LokPilot decoder is the first choice for any sophisticated model train enthusiast that places great value on excellent load control, outstanding driving characteristics at low speed, and the utmost flexibility due to adaptation to specific requirements. LokPilot decoders automatically detect the operating mode and are suitable for all commonly used motors. LokPilot decoders of the third generation offer you flexibility and reliability that you would expect from a state-of-the-art decoder. Future standards do not represent a problem either: due to the flash technology, you can update the decoder at any time.

In order to suit the different scales and the related current draw of the model locomotives, all LokPilot V3.0 decoders come in various options that we now would like to introduce to you.

LokPilot V3.0 decoders - an overview

5.1.1. LokPilot V3.0 Decoders – an Overview

	LokPilot micro V3.0		LokPilot micro V3.0 DCC		LokPilot V3.0			LokPilot V3.0 DCC		LokPilot V3.0 mfx		LokPilot XL V3.0	LokPilot Fx V3.0			
DCC Operation	Ok		Ok		Ok			Ok		-		Ok	Ok			
Motorola Operation	Ok		-		Ok			-		Ok		Ok	Ok			
mfx Operation	-		-		-			-		Ok		-	-			
Selectrix Operation	Ok		Ok		Ok			-		-		-	-			
Analogue DC Operation	Ok		Ok		Ok			Ok		Ok		Ok	Ok			
Analogue AC Operation	-		-		Ok			-		Ok		Ok	Ok			
DCC programming modes	Ok		Ok		Ok			Ok		-		Ok	Ok			
Motorola programming mode using 6021, Mobile Station, Central Station	Ok		-		Ok			-		Ok		Ok	Ok			
mfx programming including automatic recognition	-		-		-			-		Ok		-	-			
RailCom option	Ok		Ok		Ok			Ok		-		Ok	Ok			
continuous motor current	0,75A		0,75A		1,1A			1,1A		1,1A		3,0A	-			
function output current	2/140mA		2/140mA		4/250 mA			4/250mA		4/250mA		8/600mA	6/250mA			
integrated PowerPack buffer capacitor	-		-		-			-		-		Ok	-			
connection type	6 pin		6 pin		8 pin		6 pin	21MTC	8 pin		6 pin	8 pin	21MTC	Terminal	8 pin	21MTC
	direct	harness	direct	harness	harness	harness		harness	harness	harness			screws	harness		
ESU item-number	52688	52687	52685	52684	52610	52612	52614	52611	52613	61600	61601	51702	52620	52621		

5.1.2. LokPilot V3.0

The LokPilot V3.0 is a multi-protocol decoder. It supports the Märklin® / Motorola® format, the DCC-format and Selectrix®. It can also work on analogue DC or AC layouts. Thus, it is ideally suitable for mixed Motorola® / DCC environments.

Due to its manifold lighting functions and its adaptability to different applications, it is the perfect all-rounder for your H0 locomotives.

5.1.3. LokPilot V3.0 DCC

The LokPilot V3.0 DCC is a thoroughbred DCC decoder. Except for the Motorola® and Selectrix® protocol, it supports all functions of the LokPilot V3.0. In analogue mode, it can only operate on DC powered layouts. The LokPilot V3.0 DCC is best suited for the DCC purist who does not require multi-protocol operation and does not want to pay for it either.

5.1.4. LokPilot V3.0 mfx

The LokPilot V3.0 mfx is designed for the mfx-data format. Besides the new central units for Märklin systems with the mfx-data format, it is also suitable for the older models such as Delta or control unit 6020 resp. 6021. Of course, you may also run it with analogue alternating current. The LokPilot V3.0 mfx represents the first choice for all friends of the „new world“.

5.1.5. LokPilot XL V3.0

The LokPilot XL V3.0 is a powerful multi-protocol decoder for Motorola® and DCC best suited for the larger scales: It can handle a motor current of 3.0A and offers 8 function outputs. Furthermore, dirty tracks finally do not spoil your fun anymore due to the integral „PowerPack“ energy buffer.

5.1.6. LokPilot micro V3.0

The LokPilot micro V3.0 is a real multi talent. Besides DCC and Motorola® and Selectrix® and a maximum current draw of 0.75A, it is ideal for the small scales with little room for decoders.

5.1.7. LokPilot micro V3.0 DCC

The LokPilot micro V3.0 DCC is a real power package: with a permitted current draw of 0.75 A this DCC decoder with RailCom® option offers the best solution for small locomotives in N and TT-scale as well as small H0 locomotives with limited room.

5.1.8. LokPilot Fx V3.0

The LokPilot Fx V3.0 is intended for vehicles without motors. It has 6 function outputs. It supports the Motorola® as well as the DCC format and is at home on analogue DC and AC layouts.

This LokPilot is ideal for using it in combination with another LokPilot or LokSound decoder.

5.2. General Properties of all Decoders

5.2.1. Operating Modes

All LokPilot V3.0 decoders (with the exception of the pure DCC decoders) are true multi-protocol decoders with automatic detection of the operating mode „on-the-fly.“ The decoder analyses the track signal and filters out the part that is reserved for it. Changing from digital to analogue and back represents no problem whatsoever. This is important in case your storage (fiddle) yard still works in analogue mode. Furthermore, all LokPilot decoders support the relevant brake modes such as ROCO®, Lenz® or Märklin® and stop as intended. LokPilot decoders achieve the maximum compatibility with the operating system in order to enable you to simulate even some unusual operational requirements.

Provided the digital system supports them, then the LokPilot V3.0 supports and automatically detects the DCC protocol with 14, 28, or 128 speed steps. Of course, operation with the long 4-digit addresses is possible as well.

Contrary to the original Märklin®-decoders, LokPilot V3.0 decoders support up to 255 addresses and 28 speed steps in Motorola® mode. With the appropriate command station such as for instance the ESU ECoS, you can expand the system limits of the Motorola® system considerably.

Some LokPilot decoders also support the Selectrix® mode.

5.2.2. Motor Control

The most important function of digital decoders is motor control. All LokPilot V3.0 decoders are designed for universal use and therefore can control all commonly available DC motors, regardless if they are by ROCO®, Fleischmann®, Brawa®, Mehano®, Bemo®, LGB®, Hübner®, Märklin® or others. Coreless motors (such as Faulhaber® or Maxon®) also work fine with LokPilot. You may continue to use any universal motors provided you replace the stator coils with a permanent magnet. You will find more info on this topic in chapter 6.6.4.2.



General Properties of all Decoders

Fourth generation load compensation works with 16 resp. 32 kHz and assures extremely silent operation, particularly with coreless motors. Due to 10-bit technology, your locomotives will crawl at a snail's pace if so desired. Load compensation is easily adjustable to various motor and gear combinations (compare with chapter 11).

With Dynamic Drive Control (DCC), you can limit the influence of load control. Thus, you can control your locomotive in small throttle notches for instance in the yard or on turnouts while the locomotive responds like the prototype at high speed on the main line (for instance when climbing a gradient). In other words, if you do not change the throttle setting then the locomotive will slow down up the hill, as does the prototype. There is more info on this in chapter 11.4.

The minimum and maximum speed of the LokPilot V3.0 is adjustable by setting three points or the speed table with 28 entries. The table is effective for all speed step ratings (14, 28, and 128 speed steps); many decoders by others do not offer this feature. Due to unique load compensation by ESU, there are no visible jerks between speed steps – even in 14-speed-step-mode.

5.2.3. Analogue Mode

Quite a few LokPilot decoders replace analogue directional relays. Therefore, you can not only set the starting speed and the maximum speed as well as pre-select which functions should be active in analogue mode: even load compensation works in analogue mode! Therefore, LokPilot V3.0 decoders are ideal for analogue locomotives: finally, you can slow down your older, fast running locomotives.

5.2.4. Functions

Standard features for LokPilot V3.0 decoders include the following features: acceleration and brake times can be separately adjusted and switched, and of course, you can switch the shunting mode. The brightness of all function outputs can be separately set and allocated to the desired function buttons (function mapping). There is a wide range of options: dimmer, flickering firebox, gyro-light and mars-light, flash and double flash, blinker and alternate

blinker as well as switch functions with timers (e.g.: for Telex) and a special coupler function for remote controlled couplers by Krois® and ROCO®.

The unique ESU function mapping enables you to allocate every function to the function buttons F1 to F15; even multiple allocations are possible. You will find more info on this in chapter 12.

5.2.5. Programming

Where intended, LokPilot decoders support all programming modes including POM (Programming-On-the-Main). You can use any NMRA-DCC compatible command station for this purpose. Even with the Märklin® central units 6020®, 6021®, Mobile Station® and Central Station® all settings are adjusted electronically. Most LokPilot V3.0 decoders support a simple-to-use programming procedure. Owners of the ESU ECoS enjoy an even more comfortable method of programming: you can read all possible settings in plain text on the large display and easily adjust them – even during operation!

5.2.6. Operational Reliability

LokPilot decoders store the current operating status. Thanks to this data storage, the decoder will start again as quickly as possible after a service interruption. Some decoders also have an integral „PowerPack“ that assures continuous power even in case of poor electrical contact.

5.2.7. Protection

All function outputs as well as the motor output have protection against overload and short circuit. We want you to enjoy your LokPilot decoders for a long time.

5.2.8. Future included

All LokPilot V3.0 decoders are suitable for firmware updates due to the flash memory. You may add new software functions at a later stage.

Installing the Decoder

6. Installing the Decoder

6.1. Requirements for Installation

The locomotive must be in perfect technical condition prior to the conversion: Only a locomotive with faultless mechanical properties and smooth running characteristics in analogue mode is worth converting to digital. Check and replace all wear and tear parts such as motor brushes, wheel contacts, light bulbs etc., if necessary.



Please take note of the remarks in chapter 3 in order to prevent possible damage of the decoder during installation!

6.2. Installing the Decoder

The components on the decoder must under no circumstances touch any metal parts of the locomotive since this could lead to short circuits and damage or even destruction of the decoder. Therefore, all LokPilot decoders (with the exception of the ones with the 21MTC-interface) come with a protective shrink sleeve.



Never wrap the decoder in insulating tape. Should there be no ventilation around the decoder, then this may lead to a heat build-up and ultimately to the destruction of the decoder. Rather apply the insulating tape to the metal parts of the locomotive. Mount the decoder at a suitable location. In most model locomotives, there is a dedicated space for the decoder. To hold the decoder in place use double sided adhesive tape or some (just a little) hot glue.

6.3. Locomotives with 8-pole NEM 652-Interface

Some LokPilot V3.0 decoders are supplied with an 8-pole interface as per NEM 652 (refer to Fig 1). Installation in locomotives with this interface is particularly easy:

- Remove the locomotive body. Please observe the instructions in the manual of your locomotive!
- Remove the dummy plug from the socket and keep it in a suitable place for later use.



Do not rely on the assumption that the wires of the harness have to face in a certain direction: the only reliable reference is the marking of pin 1.

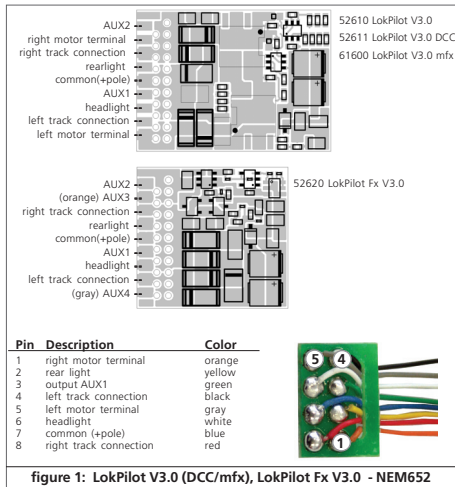

- Insert the plug of the decoder in such a way that pin 1 of the plug (this is the side with the red / orange wires) sits next to the corner of the socket that is usually marked with *, +, • or 1. Please make sure that the pins are straight when inserting the plug.

6.4. Locomotives with 6-pole NEM 651-Interface

Some LokPilot V3.0 decoders have a 6-pole NEM 651 plug (as per Fig. 2). Installation in locomotives with this interface is particularly easy:

- Remove the locomotive body. Please observe the instructions in the manual of your locomotive!

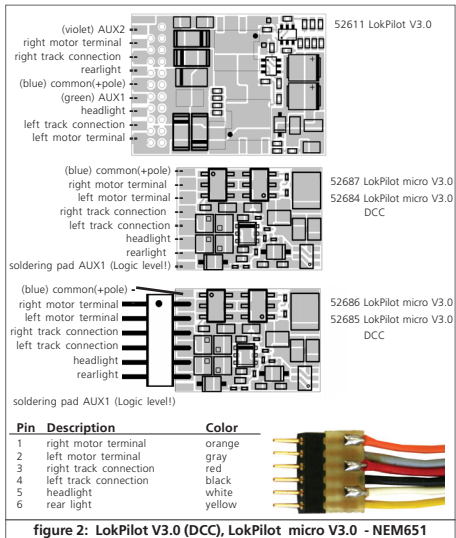

figure 2: LokPilot V3.0 (DCC), LokPilot micro V3.0 - NEM651

- Remove the dummy plug from the socket and keep it in a suitable place for later use.
- Insert the plug of the decoder in such a way that pin 1 of the plug (this is the side with the red / orange wires) sits next to the corner of the socket that is usually marked with *, +, • or 1. Please make sure that the pins are straight when inserting the plug.

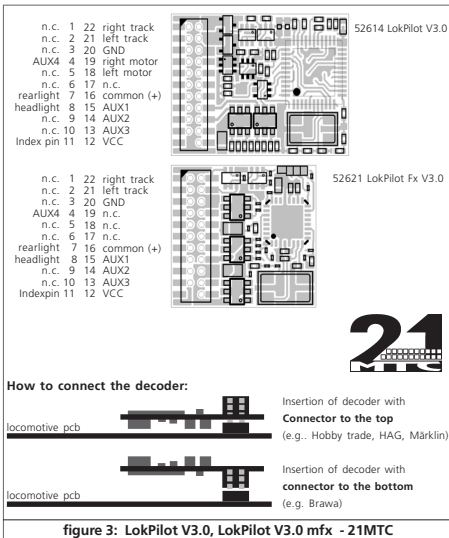

figure 3: LokPilot V3.0, LokPilot V3.0 mfx - 21MTC



How to connect the decoder:



6.5. Locomotives with 21MTC Interface

Some LokPilot decoders are available with a variant of the 21MTC interface as per Fig. 3. Installation in locomotives with this interface is particularly easy since the plug-socket connector facilitates the mechanical fixing as well.

- Remove the locomotive body. Please observe the instructions in the manual of your locomotive!
- Remove the dummy plug from the socket and keep it in a suitable place for later use
- Search for the missing pin in the plug on the circuit board of the locomotive. The missing pin serves as the marker. Memorise its location.
- You can insert the decoder in two ways: either the pins are put through the decoder; the socket of the decoder remains visible after installation (mounting on top) or the decoder is inserted in such a way that the pins go straight into the socket. Once the decoder sits in the socket, the socket is hidden from view. This method is common for Brawa locomotives.
- Which of the two mounting positions is the correct one depends solely on the locomotive. The position of the marker-pin is the crucial indicator.
- Plug the decoder into the socket in such a way that the locomotive interface corresponds with the decoder.
- Do not apply too much pressure when inserting the plug. The decoder must go in without force.
- Check if the decoder sits correctly.

6.5.1. Connecting C-Sine motors („SoftDrive-Sinus“)

The LokPilot decoder cannot drive the newer Märklin®-models with C-Sine motors (also called „SoftDrive-Sinus“) directly. To facilitate this, a circuit board supplied with the locomotive is required. Märklin uses the 21MTC interface installed on this circuit board and thus utilises the normal motor commands from the decoder for the exchange of information.

Both the LokPilot V3.0 and the LokPilot V3.0 mfx with the 21MTC interface are suitable for controlling the C-Sine control electronics provided some parameters are set accordingly. Chapter 11.5. explains the necessary steps.



Some Trix® locomotives have the same C-Sine motor; however, the control electronics in Trix® locomotives communicate in a different manner with the decoder. Currently it is not possible to run such locomotives with LokPilot decoders even though they have the same (mechanically identical) interface.

6.6. Locomotives without Interface

All LokPilot decoders have the interface (plug). There is no „wires-only“ version. Please remove the plug at the end of the harness should this become necessary.



Please do not extend any wires at the decoder end. If necessary use an extension harness (also refer to chapter 18).

6.6.1. Wiring Diagram for LokPilot or LokPilot micro

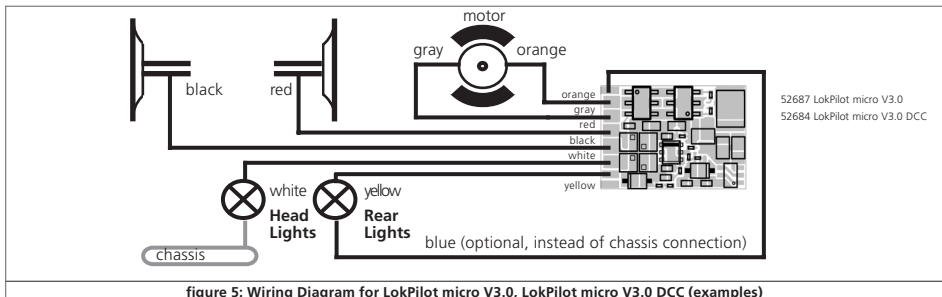
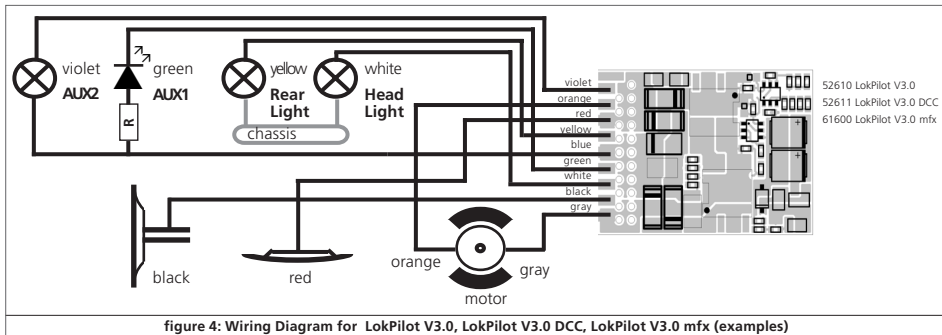

Installing the Decoder

6.6.2. Wiring Diagram for a LokPilot XL Decoder

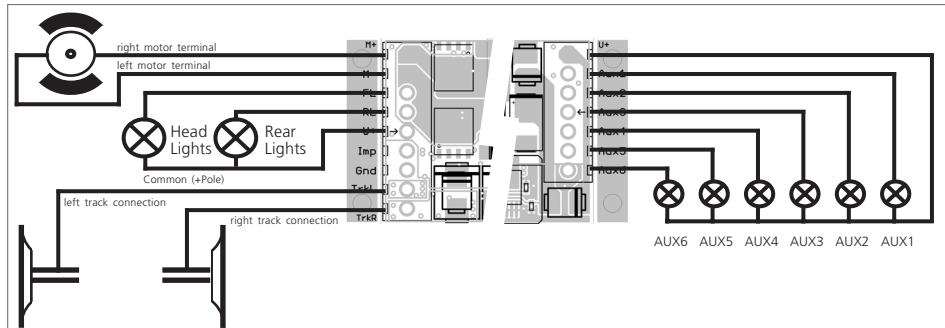

figure 6: Wiring diagram for LokPilot XL V3.0(examples)

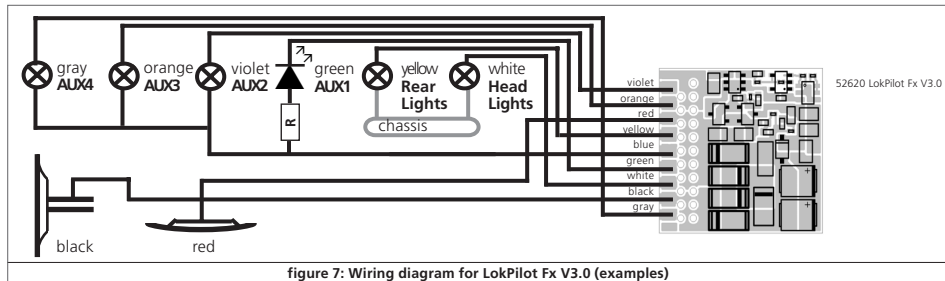

figure 7: Wiring diagram for LokPilot Fx V3.0 (examples)

6.6.3. Colour Coding by Märklin®

Märklin® uses a different colour coding system compared to the DCC colours. Please refer to Fig. 8 for more information.

6.6.4. Motor and Track Connections

Firstly, please cut all wires installed in the locomotive. Take special care to remove any connections to the chassis: the motor leads must be positively potential-free, in other words they may not have any contact to the chassis or body or the wheels and wheel contacts. It is particularly easy to overlook such connections in Fleischmann® locomotives.

Make notes of which motor lead connects the motor with the right and the left wheel contact. This avoids mistakes and assures that your locomotive runs in the right direction.



Please check all connections with an Ohmmeter. Search for short circuits, particularly between the motor leads and the wheel contacts.

- Connect the red wire to the right rail pickup or the centre pick up in AC models.
- Connect the black wire to the left rail pickup or the chassis in AC models.
- Connect the orange wire with the motor terminal, which originally lead to the right wheel pick up (centre pick up in AC models).
- The grey wire goes to the terminal, which originally connected to the left rail (chassis for AC models).

6.6.4.1. Connecting DC and Coreless Motors

You may use all DC motors commonly used for model trains provided they do not exceed the current limit of the decoder.

In some cases with the 5-pole High Performance Drive by Märklin®, you may find three anti-interference capacitors:

the two capacitors connected directly to the motor leads and the motor housing **MUST** be removed (also refer to Fig. 9 on the following page).

Description	Märklin color	ESU color (following NMRA DCC standard)
AC: Power pickup show („Schleifer“) (Center Rail) DC: right track connection		red red
AC: Outside Rails DC: left track connection	brown	black
left motor terminal	blue	orange
right motor terminal	green	gray
common (rectified track voltage) (+Pole) for function outputs	orange	blue
function output Rearlights	yellow	yellow
function output Headlights	gray	white
function output AUX1	brown/red	green
function output AUX2	brown/green	violet
function output AUX3 (logic level only occasionally, depending on decoder type)	brown/yellow	-
function output AUX4 (logic level only occasionally, depending on decoder type)	brown/white	-

figure 8: Colour coding by Märklin® in contrast to the DCC wiring code

Installing the Decoder

6.6.4.2. Connecting Universal Motors with HAMO-Conversions

Do not wire universal motors installed in many older Märklin® locomotives (also known as AC motors) directly to LokPilot decoders. You must modify the motor by first installing permanent magnets – so called HAMO magnets. You may purchase these magnets from your ESU dealer.

We supply three types of magnets. Please refer to chapter 18.2. for more information regarding motor conversions with permanent magnets.

6.7. Connecting Functions

You can wire any kind of load such as light bulbs, LEDs (light emitting diodes), smoke generators or similar devices to the function outputs provided the maximum current draw is less than that of the decoder output.

i The permitted maximum current draw per function output is listed in chapter 20 under „Technical Data.“

! Please make sure that the load does not exceed the permitted maximum current and there are no short circuits. The outputs of the LokPilot have protection but if an external voltage is applied, the outputs may suffer damage or destruction.

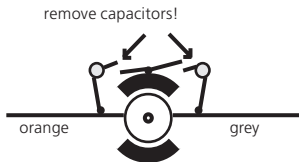

figure 9: 5-pole Märklin® motor

6.7.1. Overload Protection of Function Outputs

The function outputs of LokPilot decoders have electronic protection against overload and short circuit. The decoder keeps checking the sum of all function output currents. If the current is too high, the decoder will switch off the outputs. After about 1 second, the decoder tries to switch them on again. Should the current still be too high – perhaps due to a short circuit – the same procedure starts again.

When using light bulbs (incandescent lamps) please note the following: they draw a very high „inrush current“ when they are switched on, that becomes lower after a few moments. Therefore, it can happen with 12V bulbs that the headlights „flash“ briefly during switch-on and then extinguish due to the overload protection of the decoder. It is important to install the correct bulbs.

6.7.1.1. Suitable Light Bulbs

i Only install bulbs rated 16V or higher and with a nominal current, that does not exceed 50 mA.

! Many older models by ROCO® and Fleischmann® have 12V bulbs installed. They draw a high current, become very hot, and may cause damage to the locomotive. Replace them with 16V bulbs.

6.7.2. Connecting the Light Outputs as well as AUX1 and AUX2

This procedure depends on the wiring of the lights and auxiliary functions in the locomotive:

a) The lamps / function outputs are insulated from the common pole (ground) (i.e.: the locomotive chassis); therefore they are potential free. Fig. 4 shows the correct wiring for the outputs AUX1 and AUX2. The functions of the locomotive must be potential-free, in other words there may not be any other connection to the function besides the wires from the decoder. The voltage at these outputs is about 1.5V lower than the track voltage. The blue wire is the „plus-pole“; the function output the „minus-pole.“

If LEDs are installed (also refer to Fig. 4, output AUX1), then a resistor must be wired in series with the LEDs. It should have a rating of between 470 Ohms and 2.2 kOhms. Running the LEDs without this resistor will lead to their destruction!

b) The **lamps / function outputs** are wired (together) against the chassis of the locomotive (as in most locomotives by Märklin® as well as in most older locomotives by Fleischmann® and ROCO®). This scenario is illustrated for the light outputs in Fig. 4 (the headlights can of course also be wired as in „a“). The wiring is simpler but the available voltage is about half.

i This type of connection is not suitable for multi-protocol operation. Both mfx and Motorola® packets are asymmetrical. Therefore, the function outputs do not have continuous power. This leads to a rhythmic flicker of the headlights (pulsing) that becomes particularly obvious with LEDs. Furthermore, the headlights will only work in one direction in analogue DC mode. Whether it will be the forward lights or the backup lights depends on which way you have placed your locomotive on the track.

- Solder the backup lights to the yellow wire, the headlights to the white one.
- The green wire connects to the function output AUX1.
- The purple wire goes to the function output AUX2.

If your locomotive is wired according to option b), then it is ready for use. Otherwise, you must connect the remaining wires of all bulbs and functions together to the blue wire. This pole may not have any connection to the chassis!

i As shown in Fig. 4 it is possible to use both options in the same locomotive.

6.7.3. Purpose of AUX3 and AUX4

6.7.3.1. LokPilot with 21MTC Interface

LokPilot decoders with 21MTC interface have two additional outputs besides the 4 standard outputs, namely AUX3 and AUX4. Since they are pure „logic-outputs,“ it is not possible to connect any external loads directly. External power transistors are required. Connect AUX3 and AUX4 via the interface; there are no wire leads. In terms of their functionality, AUX3 and AUX4 are equal to the other outputs.

6.7.3.2. LokPilot Fx V3.0

The LokPilot Fx V3.0 offers up to 6 function outputs (also refer to Fig. 7). You can access the outputs AUX3 and AUX4 via the orange resp. the grey wire.



For all other LokPilot decoders the orange and grey wires are the motor leads. The LokPilot Fx V3.0 is an exception.

6.7.4. Suitable Smoke Generators

Unfortunately, it is not an easy task to find the right smoke generator for each locomotive. The amount of smoke generated depends on the following factors:

a) Track voltage

The track voltage varies depending on the command station. Therefore, it is possible that a locomotive generates smoke when driven by one digital system but does not generate any smoke with another system. Even 1V variation makes a big difference.

b) Type and tolerance of the Seuthe smoke generator and the smoke distillate

Seuthe smoke generators have considerable production tolerances. Therefore, it is possible that one unit works perfectly well while another does not. Type of distillate and filling level have an influence as well.

Installing the Decoder

c) Setting the decoder output

For correct smoking action you should set the AUX output to „Dimmer“ as well as full „Brightness.“ More info in chapter 12.

d) Connecting the smoke generator

Most smoke generators are wired against the chassis. Therefore the smoke generator only receives current in every second half cycle. How much power gets to the smoke generator depends on your command station and the digital protocol. Generally, Seuthe type 11 is recommended, but it does not get enough power and therefore does not smoke satisfactorily.

There are two options on how to solve this problem:

Solution 1: Using the Seuthe No. 10. This type is intended for analogue operation and draws a relatively high current. Subject to its tolerance levels, it may trigger the overload protection of the decoder. In this case, you must wire a relay (ESU No. 51963) into the circuit or you slightly reduce the „Brightness“ of the output.

Solution 2: Using the Seuthe No. 11. Do not wire it against the chassis but rather use the blue wire for the second pole („U+“). This prevents the asymmetric track signal from interfering with the smoke generator. It represents the best solution but is sometimes a bit difficult in terms of wiring.

6.8. Connecting Capacitors

On many older layouts, current pick up of locomotives is not very reliable. Therefore, power interruptions may cause a stop or jerky movement when the locomotive travels over turnouts at low speeds. This can be overcome with buffer capacitors (100 uF / 25V or higher show the desired results). If desired you may connect them to the LokPilot decoders.



Soldering wires onto a decoder requires quality soldering equipment and experience. Our warranty does not cover damage caused by inappropriate soldering. Consider carefully if you really need that capacitor.

6.8.1. All LokPilot H0

You can connect two larger capacitors as per the circuit in Fig. 11. One buffers the motor output, the smaller capacitor supports the microcontroller of the decoder. The capacitor is charged via a resistor (100 Ohms) thus preventing the digital system from interpreting the charging current as short circuit at the time of switch-on. The diode makes sure that the energy of the capacitor is fully available when required.



However, you may not run this locomotive on AC layouts anymore. Risk of destruction!



Disconnect / remove the capacitor prior to programming with the ESU LokProgrammer!

6.8.2. Integral „PowerPack“ in LokPilot XL V3.0

The LokPilot XL V3.0 comes ex works with a particularly powerful energy buffer. This „PowerPack“ allows your locomotive to keep running for 2 seconds without power. The PowerPack does not have to be configured, it simply works anytime. Please consider the following aspects:

- The PowerPack only operates in digital mode. It automatically turns off on analogue layouts.
- It may take up to two minutes to fully charge the capacitor („GoldCap“). Therefore, the time bridged with the energy buffer depends on the current draw of your locomotive and the charge-up time.
- You may notice a certain reduction in the speed of a fast running locomotive whenever the PowerPack provides power to the locomotive. This is quite normal and does not represent faulty behaviour.
- For safety reasons the PowerPack switches off the motor after about 2 seconds even if there is still enough energy available. Please also bear in mind that the locomotive may take up to 2 seconds before responding to the emergency stop button!

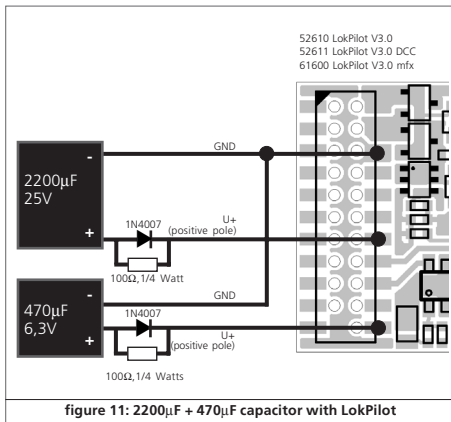

7. Initial Operation

7.1. Factory Default Values

The address is set to 03 with 14 speed steps.

LokPilot V3.0	LokPilot V3.0 DCC	LokPilot V3.0 mfx
LokPilot micro V3.0	LokPilot micro V3.0 DCC	
LokPilot XL V3.0		

- F1 switches output AUX1.
- F2 switches output AUX2.
- F3 switches the shunting mode on and off.
- F4 switches the acceleration and deceleration on and off.
- F5 switches output AUX3 (if available).
- F6 switches output AUX4 (if available).
- F7 switches output AUX5 (if available).
- F8 switches output AUX6 (if available).

LokPilot Fx V3.0

- F1 switches output AUX1.
- F2 switches output AUX2.
- F3 switches output AUX3.
- F4 switches output AUX4.
- Does the locomotive move in both directions?
- Does the indicated direction of travel correspond with the actual one? If not, are the motor leads swapped or is the 8-pole plug inserted the wrong way round?
- Switch on the lights: do they work properly? If you have installed a LokPilot with an 8-pole plug, check if the plug sits in the socket correctly.

7.2. Digital Operating Modes

In the following chapters, we describe operation of the LokPilot with different digital systems.

i Since not every LokPilot supports all digital systems, we state which chapter is applicable for which type.

7.2.1. DCC Mode

LokPilot V3.0

LokPilot V3.0 DCC

LokPilot micro V3.0

LokPilot micro V3.0 DCC

LokPilot XL V3.0

LokPilot Fx V3.0

i Remove any capacitors that are wired into the track feeders (e.g. ROCO® feeder track). This could impair the functionality of the decoder.

The LokPilot works with any DCC system. Unfortunately, the DCC protocol also brings some difficulties into the game. One of them occurs so often that we deal with it right away.

7.2.1.1. DCC Speed Steps („flashing lights“)

„Lights do not work“ with DCC systems: DCC locomotives run with 14, 28, or 128 speed steps. The decoder must „know“ the speed step setting of the command station. The command station must be able to operate with this mode and must be set accordingly. If this is not the case, the following problems may occur:

- You cannot switch the lights with F0 at all.
- The lights keep switching on and off dependent on the speed step.

In this case, make sure that the speed step settings of decoder and command station are the same.

7.2.1.2. Auto-detection of DCC Speed Steps

LokPilot decoders implement auto-detection to avoid the above problem. We have tested this with the following systems:

- ESU ECoS®,
- Bachmann E-Z-Command® Dynamis®,
- ROCO® Lokmaus2 and Lokmaus3,
- Uhlenbrock® Intellibox,
- Lenz® Digital plus V2.3,
- ZIMO® MX1.

i When operating with Lenz® digital plus V3.0 the auto-detect feature does not work at 14 speed steps. Select 28 / 128 speed steps instead.

The LokPilot tries to establish the speed step setting every time it receives power (i.e.: after switching on the power on your layout or the track sector where your locomotive is located) and the lights are switched on. This process requires that you switch on the lights and turn the throttle until the lights light up continuously.

Should you change the speed step setting during operation then you must interrupt the power to the decoder for a short moment in order to activate the auto-detection.

This auto-detect feature can be turned off with bit 4 in CV 49 (also refer to the CV table in chapter 12.1). Then you have to set the correct speed step with bit 5 in CV 29.



7.2.2. Motorola® Mode

LokPilot V3.0	LokPilot V3.0 mfx
LokPilot micro V3.0	
LokPilot XL V3.0	
LokPilot Fx V3.0	

The LokPilot works with all Märklin® devices and compatible systems that are in the market until now. The functions F1 to F4 can only be activated with the so-called „new Motorola® format.“ In order to activate this you must set the DIP-switch 2 on your 6021 to the upper position („On“).

LokPilot decoders support two special features in Motorola® mode:

7.2.2.1. 28 Speed Steps

While the original Motorola® system used by the following central units, namely Märklin® central unit 6021, Delta® and Mobile Station®, only supports 14 speed steps, the LokPilot decoder can also handle the 28-speed step mode. In conjunction with suitable command stations (e.g.: ESU ECoS, in „Motorola® 28“ mode) this leads to smoother control of your locomotives. No changes are required on the decoder.

7.2.2.2. Extended Motorola® Address Range

While the original Motorola® format only knows the addresses from 01 to 80, the LokPilot offers the following range of addresses:

LokPilot V3.0	01 - 255
LokPilot V3.0 mfx	01 - 255
LokPilot XL V3.0	01 - 255
LokPilot micro V3.0	01 - 127
LokPilot Fx V3.0	01 - 127

Chapter 9 explains how to set the address.

7.2.3. Selectrix® Mode

LokPilot V3.0		
LokPilot micro V3.0		
LokPilot XL V3.0		

You may operate the LokPilot with any Selectrix® compatible command station with access to the functions „lights“ and F1.



For programming any parameters, you must use the DCC programming mode. It is not possible to program it with a „pure“ Selectrix® system. Any changes programmed in DCC are also valid for operation with Selectrix® command stations.

As soon as a decoder receives commands in Motorola® or DCC format (whenever it receives a signal packet with information addressed to it), the Selectrix® receiver switches off automatically. This allows trouble-free mixed operation with Selectrix® / DCC / Motorola®. The Selectrix® receiver turns on again as soon as the decoder detects a power interruption.

7.2.4. mfx® Mode

	LokPilot V3.0 mfx

The LokPilot mfx is recognised and embedded into the system automatically by the Märklin® systems devices Central Station® and Mobile Station® immediately after placing the locomotive onto the track. This process runs automatically and does not require any specific decoder settings.

As soon as the decoder receives a valid mfx® data packet (whenever the decoder recognizes that it is run by an mfx® capable central unit) it will ignore Motorola® data packets. Only after interrupting power to the decoder briefly or if it does not receive any mfx® data packets for about 4 seconds will it accept Motorola® data packets again.

Initial Operation

7.3. Analogue Mode

All LokPilot decoders are set ex factory to operate in analogue mode as well.



Please take note of the remarks in chapter 10.4 if the decoder should move repeatedly from analogue into digital sectors and back.

7.3.1. Analogue DC operation

LokPilot V3.0

LokPilot V3.0 DCC

LokPilot micro V3.0

LokPilot micro V3.0 DCC

LokPilot XL V3.0

LokPilot Fx V3.0

LokPilot decoders work on conventional DC layouts. Ex works, load compensation is active. This provides smooth control of your locomotives even at low speeds (in DC mode as well). Since load compensation requires about 3 – 4 Volts as „base voltage“ you must turn the throttle further than normal (=locomotives without decoder) before the locomotive starts moving.

7.3.2. Analogue AC Operation

LokPilot V3.0

LokPilot V3.0 mfx

LokPilot XL V3.0

LokPilot Fx V3.0



Other LokPilot decoders than the ones mentioned above are not suitable for analogue AC mode. AC will definitely lead to the destruction of the decoder!

Where intended, LokPilot decoders support operation with AC transformers. Therefore, the LokPilot decoder can simply replace the old directional relay. Load compensation is active (similar to DC mode) and provides smooth control and slow-speed-performance you have never seen before. The LokPilot V3.0

recognised the pulse for changing direction as usual. Just wait until the locomotive has stopped prior to changing direction.



Never issue the „Change of Direction“ command to a moving locomotive! This could lead to damaged gears!



We cannot recommend the use of the old (blue) Märklin® transformers that were originally designed for 220 Volt. Depending on their age and their tolerance range, the pulse for changing direction could be too high in case of increased mains voltage and therefore destroy the LokPilot decoder.

Do yourself and your locomotives a favour and purchase a Märklin® transformer No. 6647– your locomotives and decoders will thank you with longer product life!

8. Decoder Settings (Programming)

Chapter 8 covers setting various parameters of the LokPilot decoder. Should you not be familiar with the handling of CVs please take the time to read these occasionally quite complex instructions.

After an introduction into the world of parameters in chapter 8.1, we explain in the following section 8.2 how to change various parameters in DCC mode and with Märklin® central units.

The chapters 9 to 16 explain which parameters have what kind of influence on the behaviour of the LokPilot decoder.

8.1. Adjustable Properties of Decoders

The hardware determines some features such as the number of function outputs as well as the maximum permitted current of the motor output and therefore they are not programmable.

Nevertheless, there are plenty of possibilities to influence the behaviour of the LokPilot decoder by adjusting software-governed properties.

There is at least one memory space within the decoder reserved for each adjustable parameter where numbers or letters can be stored.

You could visualize the storage spaces as index cards in a large file box. In order to enable you to find the right card again, they all have numbers and / or names outlining the properties of this particular card such as „locomotive address“ or „maximum speed.“

Then imagine that you can write information onto these cards. Adjusting the settings means nothing else but erasing one entry and replacing it with another. Moreover, you could do that at any time. However, you cannot write onto every card: some bits of information like the manufacturer's code are firmly encoded. Thus, you can determine the content of the storage spaces in the decoder even during operation and of course, the decoder will follow the instructions. Via the procedure known as „Programming,“ you can enter the desired data into the storage spaces.

The philosophy regarding the structure of and access to these storage spaces in the decoder varies greatly between manufacturers. While most LokPilot decoders utilise the CV concept as outlined in chapter 8.1.1., Märklin® applies a different concept with mfx® that is illustrated in chapter 8.1.2.

8.1.1. Configuration Variables (CVs)

LokPilot V3.0

LokPilot V3.0 DCC

LokPilot micro V3.0

LokPilot micro V3.0 DCC

LokPilot XL V3.0

LokPilot Fx V3.0

Almost all 8.1.1. Configuration Variables (CVs) LokPilot decoders follow the CV concept developed in the US. CV stands for „Configuration Variable“ and indicates that the storage cells described above are not only variable but they also determine the behaviour of the decoder.

8.1.1.1. Standardisation in the NMRA

The NMRA (National Model Railroad Association) has defined which CVs determine certain parameters of a decoder. The DCC standard allocates fixed numbers for certain CVs (adherence is obligatory). This greatly simplifies things for the user since decoders of most manufacturers comply with this standard and therefore dealing with CVs requires the same process with the same CV-numbers regardless of the manufacturer.

The DCC concept permits to enter numbers ranging from 0 to 255 into CVs. Each CV carries only one number.

i While the position number is predetermined, the range of values may vary. Not all CVs must accept values ranging from 0 to 255. The permitted values for LokPilot decoders are listed in the table in chapter 20.1. showing all available CVs.

8.1.1.2. Bits and Bytes

Most CVs contain numbers: CV 1 for instance contains the locomotive address. This can be any number between 1 and 127. While most CVs expect numbers to be entered, some others are rather like a „collection point“ of various „switches“, that administer different functions in one CV (mainly „on“ or „off“: CVs 29 and 49 are good examples: you must calculate the value for these CVs yourself. The value depends on which settings you want to program:

Have a look at the explanations for CV 29 in the table in chapter 20.1.:

firstly, decide which options should be active. The column „Value“ has two numbers for each option. If the option is switched off, the value is 0. Otherwise, it is a number between 1 and 128.

Add all the values for the respective options to arrive at the correct value for this CV.

Programming

Example: Let us assume you want to run trains with the ECoS in DCC mode with 128 speed steps. Analogue detection should be active (because you also want to drive your locomotive in analogue mode). All other options are not active.

Therefore, you must write the value 6 in CV 29 ($0 + 2 + 4 + 0 = 6$).

8.1.2. mfx Configuration Range

		LokPilot V3.0 mfx

The NMRA CV concept as described above has some disadvantages: On the one hand dealing with „collection CVs“ such as CV 29 with its binary format is complicated while on the other hand you can only enter one value (!). How could one possibly store locomotive names with this method?

Furthermore, it is not possible for the command station to find out, which CVs a decoder supports. The NMRA has simply „forgotten“ to define a mechanism for providing feedback from the decoder to the command station regarding the supported CVs.

With the introduction of the mfx® system the user does not have to deal with CVs, values and the binary system. The command station should rather request the decoder to provide this kind of information and then enable the user to enter any values in an easy way on the graphic interface.

For instance, you do not have to enter the value 15 in CV 3 on an mfx® capable command station but rather set the acceleration time to 10 seconds. Thanks to mfx® you do not have to remember that CV 3 contains the value for the acceleration time and that the value 15 is equivalent to about 10 seconds. This kind of complex technology is hidden in the mfx® command station.

Therefore the mfx® system does not cater for a direct method of influencing the memory spaces, the so-called mfx® configuration area of the decoder. Generally, mfx® only permits access via the

command station.

This method has only one drawback. How can the owners of other command stations that are not mfx® capable access the configuration area? This is facilitated by means of a register concept that is somewhat similar to the NMRA DCC CVs. Unfortunately this does not provide access to all characteristics of the mfx® decoder. In chapter 20 you will find a list with all decoder parameters that cannot be accessed with non-mfx® command stations. You can only write them by using the Motorola® protocol but you cannot read any decoder data.

i Therefore mfx® decoders cannot be programmed with pure DCC command stations since the parameters can only be accessed with either the mfx® or the Motorola® protocol.

i In order to utilise the full capability of the LokPilot mfx®, we recommend to program them either with an mfx® capable command station or with the ESU LokProgrammer. Any settings programmed there are also valid when operating the decoder with another command station.

8.2. Programming with popular Digital Systems

As already explained it is not possible to program every type of LokPilot with every command station in the market. This chapter explains which options are available.

8.2.1. Programming with DCC Systems

LokPilot V3.0	LokPilot V3.0 DCC	
LokPilot micro V3.0	LokPilot micro V3.0 DCC	
LokPilot XL V3.0		
LokPilot Fx V3.0		

LokPilot decoders support all NMRA programming modes as there are the programming track modes (Direct Mode, Register Mode, Paged Mode) and the mode for the main („POM“, „Programming on the Main“).

Programming on the Main enables you to program your decoders comfortably without having to remove the locomotive from the layout. In this case, the command station talks directly to the



decoder by using its locomotive address, for instance: „Locomotive number 50, write the value 7 into CV 3!“. Thus knowing the locomotive address is a precondition.

i Unfortunately, you cannot read CV values. However, with RailCom® you can read CV values on the main. More on this topic in chapter 16.

Assuming you have a suitable DCC system you can read CV values on the programming track. You can also reprogram the locomotive address without knowing the old address since the command station simply transmits the command „Write value 7 in CV 3!“. Each decoder receiving this command will execute it.

i ESU counts the bits from 0 to 7 as laid out in the standards while others (e.g.: Lenz) count the bits from 1 to 8. Please bear this in mind when you program one of our decoders with another digital system.

8.2.2. Programming with the ESU ECoS

LokPilot V3.0	LokPilot V3.0 DCC	LokPilot V3.0 mfx
---------------	-------------------	-------------------

LokPilot micro V3.0	LokPilot micro V3.0 DCC
---------------------	-------------------------

LokPilot XL V3.0

LokPilot Fx V3.0

The owners of an ESU ECoS can comfortably program LokPilot decoders. ECoS has a library of „Decoder Profiles“ that help you to program decoders with the graphic display. All CVs are stored in the decoder profile thus enabling the ECoS to read them and to display them on the screen. Chapter 16.5. of the ECoS manual provides more information on this topic.

i Please make sure that you always use the latest ECoS firmware version. Whenever we expand the range of the LokPilot family, only an update will add the required decoder profile.

! With ECoS you can program LokPilot mfx decoders only to a limited degree. For technical reasons, there is no decoder profile for a LokPilot mfx decoder. You can only access the CVs as listed in chapter 20.2. You can access them with the Motorola®

programming mode as described in chapter 16.2. in the ECoS manual.

8.2.3. Programming with Märklin® 6021

LokPilot V3.0		LokPilot V3.0 mfx
---------------	--	-------------------

LokPilot micro V3.0	
---------------------	--

LokPilot XL V3.0

LokPilot Fx V3.0

The Märklin® central unit 6021 works differently: Since it does not comply with the NMRA DCC standards, LokPilot decoders start a special, obligatory programming procedure. Reading of values is not permitted.

There are two modes:

In the short mode parameters with a number below 80 can be set provided the desired value is also lower than 80.

In the long mode, all parameters with values from 0 to 255 are adjustable. Since the display of the 6020 /6021 is limited to two-digit numbers, values must be split and entered in two separate steps.

! The LokPilot XL V3.0 is capable of handling both the short and the long mode. LokPilot V3.0 decoders starting with software version 0.0.6460 support the long mode. The LokPilot micro V3.0 and the LokPilot Fx V3.0 can only handle the short mode.

8.2.3.1. Changing the Programming Mode

Enter the programming mode with the 6020/6021:

The throttle must be set to „0“ 8.2.3.1. Wechseln in den Programmiermode. No other locomotives may be on the layout. Watch out for flashing signals of the locomotive!

- Press the „Stop“ and „Go“ buttons of the 6021 simultaneously until a reset has been triggered (alternately pull the mains plug of the transformer). Press the „Stop“ button in order to switch off the track voltage. Enter the current decoder address. If you do not know the current address, simply enter „80“.
- Activate the change-of-direction button (turn the throttle knob to the left beyond the arrestor until you hear a click sound), hold it in this position and then press the „Go“ button.



Please bear in mind that the 6020/6021 only permits you to enter values from 1 to 80. The value 0 is missing. Always enter „80“ instead of „0“.

8.2.3.2. The Short Mode

The decoder is in the short mode (the headlights flash periodically in brief intervals).

- Now enter the number of the CV that you want to adjust e.g.: „01“. Always enter this number with two digits.
- For confirmation activate the change-of-direction routine (now the lights flash twice very quickly).
- Now enter the new value for the desired CV, e.g.: 15 (two digits).
- For confirmation activate the change-of-direction routine (now the lights light up for about one second).
- Then you can enter other CVs as desired.
- Selecting „80“ allows you to exit the programming mode. Alternately you can switch off the track voltage and then on again (press the „Stop“ button on the 6021, then the „Go“ button).

8.2.3.3. Long mode

You access the long mode by entering the value 07 in CV 07 while in the short mode. The decoder confirms the change to the long mode by slowly flashing lights.

- Enter the hundred-digit and the ten-digit (decade) of the CV that you want to change. Example: If you want to adjust CV 124, you enter „12“.
- For confirmation activate the change-of-direction routine (now the lights flash periodically: long – short – long – short – etc.)
- Now enter the unit of the CV („4“ in this example).
- For confirmation activate the change-of-direction routine. Now the decoder expects the entry of the CV value. The lights flash periodically: long – short – short).
- Now enter the hundred-digit and the ten-digit (decade) of the new CV value (as a two-digit number). Example: You want to write the value 135. Therefore, you enter „13“.
- For confirmation activate the change-of-direction routine. Now the lights flash periodically: long – short – short – short).
- Now enter the unit of the new CV value as a two-digit number („05“ in this example).
- For confirmation activate the change-of-direction routine (now the lights light up for about one second).
- Now you can adjust more CVs in long mode.
- Exit the long mode by switching off the track voltage and then on again (press the „Stop“ button on the 6021, then the „Go“ button).

8.2.4. Programming with the Märklin® Mobile Station®



Like any other mfx decoder, the LokPilot mfx reports automatically to the Mobile Station® and can be programmed with the mechanisms described there.



With the Mobile Station®, you can also adjust some of the CVs. Use the Register Programming Menu to facilitate this.



As with the 6021, you can only enter values between 1 and 80. The possible CV values are also limited to that range from 1 to 80.

You will find the programming menu in the locomotive menu of the Mobile Station®. It is only available for certain locomotives. Of course, this works only for a programmable locomotive.

Proceed as follows:

- Enter a new locomotive in the database. How you do this is explained in the manual for the Mobile Station®.
- Select locomotive 36330. The locomotive Ex 3/3 is shown as active on the display.
- By pressing the „MENU / ESC“ button you can now change any of the settings such as name, address, etc. in the heading „CHANGE LOCOMOTIVE“. The last function shown is „Register Programming“ (REG). Select this for writing CVs.

- Then select the CV (called „REG“ on the Mobile Station®) and then the desired value and confirm by pressing the change-of-direction button.
- The Mobile Station® will program the new value into the decoder.



Please remove all other locomotives prior to programming!

8.2.5. Programming with the Märklin® Central Station



Like any other mfx decoder, the LokPilot mfx reports automatically to the Central Station® and you can program them with the mechanisms described there.



With the Central Station®, you can program the CVs 1 to 80 via the Motorola® programming menu. Unfortunately, you can only enter values between 1 and 80.

Find more information regarding this programming mode in chapter 8 of the manual of the Central Station®.

8.2.6. Programming with the ESU LokProgrammer

LokPilot V3.0	LokPilot V3.0 DCC	LokPilot V3.0 mfx
LokPilot micro V3.0	LokPilot micro V3.0 DCC	
LokPilot XL V3.0		
LokPilot Fx V3.0		

The LokProgrammer 53450 / 53451 offers the easiest and most comfortable way of setting the CVs of LokPilot decoders: simply by a few mouse clicks on an MS-Windows® computer. The computer saves you to look for the various CV numbers and values. More information is contained in the manual for the LokProgrammer.

i You can access all properties of ESU decoders with the LokProgrammer. Since this works independently from the data format it also works for mfx® decoders.

9. Address Settings

Each LokPilot decoder requires a definite address to be addressable for the central unit. Depending on the type of decoder and the digital system, there are several possibilities how to allocate addresses.

9.1. Short Addresses in DCC Mode

LokPilot V3.0	LokPilot V3.0 DCC	
LokPilot micro V3.0	LokPilot micro V3.0 DCC	
LokPilot XL V3.0		
LokPilot Fx V3.0		

Normally you would control LokPilot decoders with the short address that is stored in CV 1. In DCC mode, the permitted values range from 1 to 127. In order to enable the decoder to „listen“ to the short address you must delete bit 5 in CV 29.

i Some digital systems (e.g.: ROCO® Lokmaus2, Lenz digital plus, Lenz compact) only support the values 1 – 99 as short address.

9.2. Long Addresses in DCC Mode

LokPilot V3.0	LokPilot V3.0 DCC	
LokPilot micro V3.0	LokPilot micro V3.0 DCC	
LokPilot XL V3.0		
LokPilot Fx V3.0		

You can operate LokPilot decoders also with long addresses (4-digit addresses). The supported values range from 128 – 10239. The long address is stored in the CVs 17 and 18. You must activate the long address by setting bit 5 in CV 29.



Bit 5 in CV 29 switches between short and long address. The decoder can only respond to one address at a time.

If you want to use your LokPilot with the long address it is practical to program this address directly with your digital system: most modern digital systems (e.g.: ESU ECoS, Bachmann E-Z Command® Dynamis®) have a menu for programming long addresses. The command station not only programs CV 29 correctly but also assures the correct storage of the values for the long address in CV 17 and 18.

If you want to enter the long address manually in CV 17 and 18 please refer to chapter 22.1.

9.3. Motorola® Address

You can also operate many LokPilot decoders with the Motorola® format. The address for this operating mode is stored in CV 1.

LokPilot V3.0

LokPilot micro V3.0

LokPilot XL V3.0

LokPilot Fx V3.0

This address is identical to the short address in DCC mode as described in chapter 9.1. The LokPilot decoder responds both to commands in DCC and in Motorola® mode at the same time. The permitted values are listed in chapter 7.2.2.2.

- i** Märklin® digital devices (6020, 6021, Delta®) can only work with addresses from 1 to 80. Should you have entered a higher value in CV 1 you will not be able to drive this locomotive with the above Märklin® central units.

LokPilot V3.0 mfx

The LokPilot mfx accepts values from 1 to 255 in CV 1. With suitable command stations such as the ESU ECoS, you have about three times as many addresses available compared to the original Märklin® decoders.

- i** The LokPilot mfx decoder accepts commands to this address only when operated with a non-mfx® command station. As soon as a LokPilot mfx decoder receives a valid mfx® data packet it switches automatically to the mfx® operating mode and ignores Motorola® commands.

9.4. Addresses in the mfx® Mode

LokPilot V3.0 mfx

The mfx® systems also use addresses for directing commands to a locomotive. However, the addresses are allocated automatically when the decoder first reports to the central unit. Neither can the user program these addresses nor can he read them.

10. Adapting the Driving Characteristics

10.1. Acceleration and Deceleration

Acceleration and brake time can be set independently from each other. Therefore, you could for instance program a short acceleration and a much longer brake time.

The time for accelerating from 0 to maximum speed is adjusted in CV 3 while deceleration is set in CV 4. Permitted values are 0 (no delay) to 63.

The times set in these CVs work speed dependant. Therefore, the acceleration distance and the brake distance are longer at high speeds. In other words, the faster the locomotive moves, the longer is the distance until it stops.

- i** For information on how to set a brake distance independently of the speed refer to chapter 10.6.

10.1.1. Switching Acceleration / Deceleration

LokPilot decoders can deactivate acceleration and deceleration by the push of a button. This is particularly handy for shunting since your locomotive responds directly to the throttle.

The default setting for this function is function button F3.

Adapting the Driving Characteristics

10.1.2. Shunting Mode

The default setting for the shunting mode is F4. It reduces the speed to about 50%. Thus, you have smoother control of your locomotive in the lower speed ranges, which is important for shunting, particularly in the 14-speed-step mode.

10.2. Starting Voltage, Maximum and Medium Speed

LokPilot V3.0	LokPilot V3.0 DCC
LokPilot micro V3.0	LokPilot micro V3.0 DCC
LokPilot XL V3.0	
LokPilot Fx V3.0	

LokPilot decoders know internally 255 speed steps. They can be adapted to the characteristic of the locomotive and allocated to the actually available speed steps (14, 28, or 128):

The NMRA defined two options to facilitate this:

Motor characteristic via CV 2, 5, and 6 (Fig. 12): enter the start voltage in CV 2 and the maximum speed in CV 5. CV 6 corresponds with the speed at a medium speed step. Thus, you can define a kink in the speed curve. This mode is active if bit 4 = 0 in CV 29.

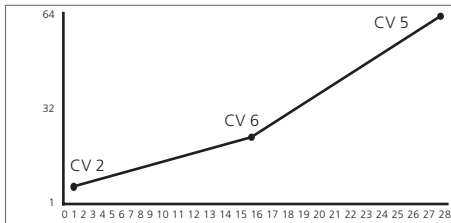

figure : speed settings using CV 2, 5, 6

i The values of the start, mid and maximum speed are dependent on each other. Selecting a mid speed that is lower than the start speed or higher than the maximum speed could lead to some erratic driving performance. Therefore always adhere to the principle: start voltage < mid speed < maximum speed.

10.3. Speed Curve

LokPilot V3.0	LokPilot V3.0 DCC
LokPilot micro V3.0	LokPilot micro V3.0 DCC
LokPilot XL V3.0	
LokPilot Fx V3.0	

You may also define your own speed curve: simply enter the desired values in the CVs 67 to 94 (also refer to Fig. 13). The decoder will superimpose these 28 values onto the real speed steps. Thus, you can adapt the driving performance optimally to your locomotive. This mode is only active if bit 4 in CV 29 is set. We recommend using the ESU LokProgrammer for easy and comfortable programming.

i When this mode is active, the settings in CV 2, CV 5, and CV 6 have no influence.

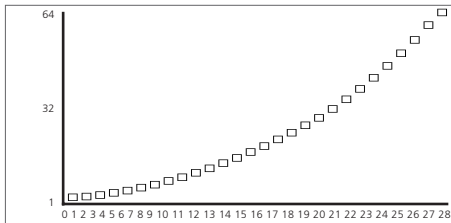

figure : speed curve

Each mfx® decoder has its own speed curve. However, it is only accessible with an mfx® capable central unit or with the ESU LokProgrammer.

10.4. Changing between Operating Modes

You may change from a digital to an analogue sector of your layout „on-the-fly“ at any time. The locomotive behaves as follows:

10.4.1. From Digital to Analogue DC

When the decoder enters the analogue DC sector, it monitors the polarity of the track voltage. If the polarity (and the resulting direction of travel as per NEM) matches the the direction of travel in digital mode the locomotive will continue without stopping at the speed that corresponds to the analogue voltage.

If the polarity does not match than the behaviour depends on the settings in CV 51.

If the DC brake mode is active in CV 51 then the locomotive will slow down to a stop with the programmed deceleration, if not, then the locomotive will change the direction and back out of the analogue sector. Chapter 10.5 provides detailed info about brake sectors and the appropriate settings.

10.4.2. From Digital to Analogue AC

If a locomotive travels into an analogue AC sector, it will continue onwards in the same direction at a speed corresponding to the analogue track voltage.

10.4.3. From Analogue to Digital (directional bit)

When entering the digital sector the locomotive compares the current direction of movement with the digital signals arriving via the track: If the actual direction matches the one as per the digital signal, the locomotive continues onwards at a speed corresponding with the digital signals.

Does the direction not match the commands from the digital system, then the behaviour depends on the settings in the „directional bit“ (also refer to chapter 14.1. for more details):

If the directional bit has been set, then the decoder ignores the directional commands from the central unit, the locomotive continues in the same direction; only the speed will be adjusted according to the commands from the central unit. Therefore, the actual direction of movement does not match the direction as intended by the central unit for the time being; however, this changes once a change-of-direction-command is activated at the central unit.

If the directional bit has not been set, then the locomotive slows down and stops according to the programmed deceleration, changes its direction and returns to the conventional sector. What happens next is described in chapter 10.4.1 resp. 10.4.2.

10.4.4. From Digital to Digital

LokPilot V3.0

LokPilot micro V3.0

LokPilot XL V3.0

LokPilot Fx V3.0

Travelling between sectors with different digital protocols, namely Motorola® and DCC is possible at any time. The LokPilot decoder interprets each valid data package from the command station.

Adapting the Driving Characteristics

LokPilot V3.0		

LokPilot XL V3.0		

Travelling from Selectrix® to DCC or Motorola® is only possible after a short power interruption (also refer to chapter 7.2.3).

	LokPilot V3.0 mfx	

As mentioned in chapter 7.2.4 travelling from Motorola® to mfx® is possible at any time, as soon as the decoder receives a valid mfx® package. When travelling in the opposite direction, e.g.: from mfx® to Motorola® (when for instance the locomotive changes to a sector of the layout that is still controlled by a 6021) the decoder will accept the Motorola® package only after about 4 seconds. The first 4 seconds the locomotive continues at the previous speed and direction.

10.4.5. Changing modes with Analogue Mode turned off

LokPilot V3.0	LokPilot V3.0 DCC	
---------------	-------------------	--

LokPilot micro V3.0	LokPilot micro V3.0 DCC	
---------------------	-------------------------	--

LokPilot XL V3.0		
------------------	--	--

LokPilot Fx V3.0		
------------------	--	--

Perhaps you have disabled analogue mode on your decoder (bit 2 in CV 29 is deleted). When the locomotive moves from the digital sector into the analogue one, the locomotive will continue with the set speed and direction. However, you cannot issue any commands to that locomotive until it is back in a digital sector.

Under certain circumstances, the decoder interprets the analogue DC voltage as brake sector and slows down to a stop; please refer to chapter 10.5.



10.5. Brake Sectors

Brake sectors have the purpose to slow down the locomotive independently from the commands issued by the command station. Frequently, this function serves for stopping a train in front of a red signal. If a LokPilot detects a brake command, it will slow down with the programmed deceleration and then stop. After this enforced stop, the locomotive will accelerate again as per the programmed values in CV 3.

Depending on the type of digital system, there are several options on how to influence the decoder so that it stops the train.

10.5.1. DC Brake Mode

LokPilot V3.0	LokPilot V3.0 DCC	
---------------	-------------------	--

LokPilot micro V3.0	LokPilot micro V3.0 DCC	
---------------------	-------------------------	--

LokPilot XL V3.0		
------------------	--	--

LokPilot Fx V3.0		
------------------	--	--

In order to activate the DC brake mode you must set bit 0 in CV 51. The LokPilot decoder will start brake once it moves from a digital sector into a DC sector provided the brake mode is active and the polarity of the track voltage does NOT match the current direction of travel. The locomotive will stop taking into account the programmed deceleration.

10.5.2. Märklin® Brake Mode

LokPilot V3.0		LokPilot V3.0 mfx
---------------	--	-------------------

LokPilot micro V3.0		
---------------------	--	--

LokPilot XL V3.0		
------------------	--	--

LokPilot Fx V3.0		
------------------	--	--

In principle, the Märklin® modules 72441 / 72442 apply a DC voltage to the track instead of the digital signals. Provided bit 0 in CV 51 is set, then LokPilot decoders detect this voltage and will stop the train.

! The signal generated by these modules looks the same as DC from conventional DC-transformers. The LokPilot could possibly misinterpret this and switch to the analogue mode instead of brake.

The logic works as follows:

- If the last package received prior to detecting analogue DC was in the Motorola® format, the decoder assumes this is a Märklin® brake section and stops.
- If the last package received prior to detecting analogue DC was in the DCC format, the decoder assumes this is an analogue sector.

! If you wish to control the LokPilot decoder with DCC signals and keep your Märklin® brake sectors then you should switch off the DC analogue mode by deleting bit 1 in CV 50. The LokPilot will stop as desired.

10.5.3. Selectrix® Diode Brake Sector

LokPilot V3.0		
---------------	--	--

LokPilot micro V3.0		
---------------------	--	--

LokPilot XL V3.0		
------------------	--	--

LokPilot decoders also detect the Selectrix®-diode brake sector and stop as desired.

10.6. Constant Brake Distance

LokPilot V3.0	LokPilot V3.0 DCC	
---------------	-------------------	--

LokPilot XL V3.0		
------------------	--	--

An attractive function hides behind CV 254 (ESU brake mode): Here you can set a constant distance for braking the train, from the beginning of the brake sector to the stopping point. Thus, it is possible to stop the train right in front of a red signal regardless of the speed. The LokPilot simply calculates the required brake

effect.

If the locomotive travels relatively slowly when it receives the brake command, it will first continue for a while before slowing down. If the locomotive travels faster when entering the brake sector, it will start braking sooner but with the same deceleration. Fig. 14 illustrates the relationship.

The higher the value in CV 254, the longer is the brake distance.

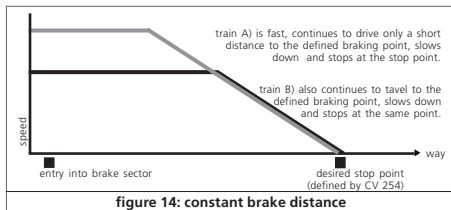

Simply make some trials on a test track in order to find the values best suited to your locomotive.

i The constant brake distance is only active in brake sectors. When you turn the throttle back to 0, the locomotive will slow down as per the value in CV 4.

If CV 254 is set to 0, then the normal time mode as per chapter 10.1. will automatically turn on.

10.7. Settings for Analogue Operation

You can adjust the acceleration and maximum speed of the LokPilot separately for analogue DC and AC mode. Thus, you can adapt the speed of your locomotive also to analogue operations.

You will have to determine suitable values by trial and error since they depend on the type of transformer (throttle) and the drive system of your locomotive.

Adapting the Driving Characteristics

i Please note that (with the exception of the LokPilot V3.0 mfx) load compensation is always active ex works, even in analogue mode. This gives you smooth control even at very low speeds.

10.7.1. DC Analogue Operation

LokPilot V3.0	LokPilot V3.0 DCC	
LokPilot micro V3.0	LokPilot micro V3.0 DCC	
LokPilot XL V3.0		
LokPilot Fx V3.0		

You can adjust the starting and maximum speed in DC analogue mode with the CVs 125 and 126.

10.7.2. AC Analogue Operation

LokPilot V3.0		LokPilot V3.0 mfx
LokPilot XL V3.0		
LokPilot Fx V3.0		

You can adjust the starting and maximum speed in AC analogue mode with the CVs 127 and 128.

11. Motor Control

LokPilot V3.0	LokPilot V3.0 DCC	LokPilot V3.0 mfx
LokPilot micro V3.0	LokPilot micro V3.0 DCC	
LokPilot XL V3.0		

4th generation load compensation enables LokPilot decoders to execute precise motor control. Even with the default settings, most locomotives run perfectly.

11.1. Adjusting Load Compensation

Should you find after programming and doing the initial test that the locomotive does not run smoothly particularly at low speed or that the locomotive jerks a little after having stopped or if you are simply unsatisfied with the driving performance, then you should adjust the load compensation of your LokPilot decoder.

Due to the large number of different types of motors and drive systems there is no single setting that suits all. Load compensation can be influenced with 4 CVs.



Firstly, check if the irregular performance is due to any mechanical faults. Bent driving rods are one common cause. When you turn off load compensation as shown in chapter 10.2 and the problem persists then it is likely there is a mechanical fault.

11.1.1. Parameter for frequently used Motors

We have listed the correct settings for the most common motors in the following table (Fig. 15). If a motor is missing, it means either that the default settings produce good results or that we have not yet sufficient experience about these motors.

Set the suitable values and test-drive your locomotive.

11.1.2. Adjustments for other Motors / „Fine Tuning“

Unfortunately, the motors available in the market have considerable variations due to tolerances. This is even true for the same type. Therefore, LokPilot decoders enable you to adapt load compensation to the motor with CVs 53, 54 and 55. If the recommended values above do not lead to acceptable results, you can further optimise them.



However, before doing this you must make sure that there are no capacitors wired between the motor terminals and the chassis. The commutator of the motor must be clean and the drive system should run freely. The wheel contacts and other contact plates of the locomotive must also be clean and make reliable contact.

11.1.2.1. Parameter „K“

Parameter „K“, stored in CV 54, influences how strongly load control will affect the driving performance. The higher the value, the more load control will respond to any changes and try to adjust the revs of the motor.

Parameter „K“ needs adjustment if the locomotive runs unevenly (jerks) in speed step 1.

Reduce the value of CV 54 by 5 and test-run the locomotive to see if there are any improvements. Repeat these steps until the locomotive runs smoothly at speed step 1.



With some motors, it may be necessary to set the starting voltage to a value between 4 and 6 in order to arrive at good results.

type of motor	remarks	CV 2	CV 53	CV 54	CV 55
Fleischmann® motor		6	40	16	20
Märklin® small „Scheibenkollektormotor“	using Magnet 51961	6	20	16	12
Märklin® big „Scheibenkollektormotor“	using Magnet 51960	6	50	16	12
Märklin® „Trommelkollektormotor“	using Magnet 51962	6	40	16	12
Märklin® 5*-high performance motor		3	40	20	38
Märklin® locomotives using Maxon motors		4	56	6 – 8	4 – 6
HAG ® motors		4	56	10	10
Trix® locomotives using Maxon Motor	remove the motor EMC capacitors from the main board!	4	56	6 - 8	4 – 6
Piko® locomotives		6	40	10 – 14	30
Güztold locomotives	(set Motor-frequency to 15 kHz, refer chapter 10.3.)	4	56	20	30
Faulhaber® motors	CV55 depends on flywheel: Sometimes CV55=30	6	40	6 – 10	8 - 10
LGB® locomotives	Using LokPilot XL V3.0	6	56	8	30
Rivarossi®	Locomotives from old production (before Hornby!)	8	30	15	40
Trix®, Fleischmann®, Roco® N scale	CV 55 depends of size of flywheel	6 – 10	50	20 –25	25 – 30

figure 15: table of BACK-EMF settings for widely used motors

11.1.2.2. Parameter „I“

Parameter „I“, stored in CV 55 provides important information to the decoder on how much inertia the motor has. Motors with large flywheels naturally have more inertia than smaller ones or coreless motors.

Adjust parameter „I“ if the locomotive jerks somewhat just before it stops or „jumps“ at lower speeds (lower third of the speed step range) or simply does not run smoothly.

- Reduce the value by 5 starting with the default value for motors with very small or no flywheels.
- Increase the value by 5 starting with the default value for motors with large flywheels.

Test again and repeat this procedure until you arrive at the desired result.

11.1.2.3. Reference Voltage

In CV 53, you set the EMF reference voltage generated by the motor at maximum revs. This parameter may have to be adapted subject to the track voltage and the efficiency of the motor.

If the locomotive reaches maximum speed when the throttle is set to about a third and the top third of the throttle has no influence on the speed, then you should reduce the value of CV 53. Reduce the value by 5 – 8 and test the locomotive again. Repeat this process until the locomotive just reaches its maximum speed when the throttle is fully open.

11.2. Turning off Load Compensation

LokPilot V3.0

LokPilot V3.0 DCC

LokPilot micro V3.0

LokPilot micro V3.0 DCC

LokPilot XL V3.0

Occasionally it may be beneficial to turn off load control; simply delete bit 0 in CV 49.

LokPilot V3.0 mfx

You can also switch off load compensation by writing the value 0 in CV 56 („Control Influence“).



With load control turned off, the starting voltage in CV 2 should be increased until the locomotive starts moving at speed step 1 or 2.

11.3. Adapting Load Control Frequency

LokPilot V3.0

LokPilot V3.0 DCC

LokPilot V3.0 mfx

LokPilot micro V3.0

LokPilot micro V3.0 DCC

LokPilot XL V3.0

In the LokPilot decoders load control works normally with 32 kHz. Sometimes it can be useful to reduce this frequency by half:

- For motors with little power due to high inductivity.
- If suppressors (such as capacitors, chokes, etc.) disturb load control but cannot be removed.

Delete bit 2 in CV 49 in order to set the PWM frequency from 32 KHz to about 16 kHz.

11.4. Dynamic Drive Control: Up and Down the Hill

LokPilot V3.0

LokPilot V3.0 DCC

LokPilot V3.0 mfx

LokPilot micro V3.0

LokPilot micro V3.0 DCC

LokPilot XL V3.0

Dynamic Drive Control (DCC) of your LokPilot decoder enables you to adapt load control, as you may desire. Full control over the entire speed range (constant speed) is not always prototypical. Therefore you can set the degree to which load control will be effective between 0 (no load control) and 100% (load compensation over the full range),

At low speeds it is advisable to have 100% load compensation in order to prevent the locomotive from „getting stuck“ or from „running away“ without any load. The impact of load control should recede with increasing speed in order to have the full „un-harnessed“ power of the motor available when the throttle is fully open. Thus, the locomotive will respond to certain changes in the main line such as gradients. The locomotive will run faster downhill and become slower climbing the hill.

The desired degree of load control influence is set in CV 56.

It is particularly meaningful to reduce the influence of load control whenever you run consists. This allows for better driving properties of all locomotives in the consist.



11.5. Settings for the C-Sinus Motor

LokPilot decoders with the 21MTC interface can drive the new C-Sinus motors indirectly via the circuit board installed in the locomotive. The LokPilot can generate all necessary signals provided you readjust certain settings:

Load compensation must be turned off as described in chapter 11.2.

The control electronics of the motor also need a switched logic voltage provided by the LokPilot on output AUX4. AUX4 must

therefore be active while the locomotive is stopped and while it is moving (in both directions!).

LokPilot V3.0

Write the values below into the respective CVs:

CV	Value
CV 129	32
CV 132	32
CV 135	32
CV 138	32

LokPilot V3.0 mfx

Use the LokProgrammer or the Central Station in order to activate AUX4 for the stationary locomotive and for the moving locomotive in both directions as shown in Fig. 16.

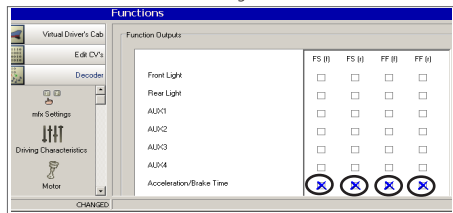

figure 16: settings for c-sinus with LokPilot mfx

12. Function outputs

12.1. Physical function outputs

LokPilot decoders have up to 8 physical function outputs. „Headlights“ and „Backup Lights“ are used for lighting, the remaining ones (AUX1 to AUX6) are freely available. Other functions include „Shunting Mode“, „Acceleration / Deceleration On/Off“ as well as virtual functions like „Sound On/Off“. We explain the importance of the latter in chapter 15.

The function buttons („F buttons“) of your command station or throttle activate the function outputs.



Generally, F0 is the lighting button, while we count the remaining buttons from F1 upwards.

12.2. Allocation of Function Buttons (Function Mapping)

LokPilot V3.0

LokPilot V3.0 DCC

LokPilot micro V3.0

LokPilot micro V3.0 DCC

LokPilot XL V3.0

LokPilot Fx V3.0

You can allocate the functions freely to any function button. ESU uses the so-called extended „Mapping“. It has the advantage that you can link each output to any button. Furthermore, the allocation can vary between forward and reverse as well. It is also possible to switch several functions simultaneously.

Two CVs (so called control CVs A and B) are allocated to each function button. They enable you to determine the behaviour of the button. Generally, one can say:

- All function buttons are directional. So if you change anything do not forget to adjust both directions.
- Some digital systems do not support all functions.
- Each physical output must first be „switched on“ and then linked to a function button.



Figure 17 on the following double page provides an overview about all possible combinations.

LokPilot micro V3.0, LokPilot micro V3.0 DCC and LokPilot Fx V3.0 support the function buttons F0 to F12, the other LokPilot decoders F0 to F15.

We will have a look at some examples in order to clarify the procedures, but first we have to explain two more properties of the function outputs.

12.3. Special Effects on Function Outputs

12.3.1. Switching on Outputs and Different Options

Each function output can / must be unlocked prior to using it. Furthermore, each output offers the choice of 12 different lighting effects:

- Dimmer: normal continuous output
- Blinker lights: the output flashes with an adjustable frequency.
- Inverse blinker lights: The output flashes as above but in the opposite direction. This feature enables you to set up alternate blinkers.
- Strobe: flash light.
- Double Strobe: double flash light.
- Firebox: flickering light simulating the open firebox.
- Zoom: slow fade-in and fade-out of light, for steam locomotives or petroleum lanterns
- Mars light
- Gyro light
- Rule 17: for US steam locomotives. Headlights and back-up lights are dimmed when the locomotive stops and go to full brightness when the locomotive moves again. Can be separately controlled for headlights and back-up lights.
- Pulse: output turns off automatically after a certain time. This is ideal for Telex un-couplers.
- Coupler function: for controlling couplers by Krois® and ROCO®

There is a CV for each output (starting with CV 113. Also compare the table in chapter 21.1.), where the desired lighting effect is set. Allocate a specific number to each lighting effect that you want to enter in the corresponding control CV.

i Please note that you can turn off each output that is not needed by entering 0.

i The two logical functions „Shunting Mode“ and „Switch off Acceleration and Deceleration“ do not need configuration CVs.

12.3.2. Adjust Lamp Brightness

In order to adapt the light intensity of the lamps the decoder can dim the brightness of each lamp in 15 steps. This is achieved by clocking, that means the lamps are switched on and off very quickly and very often. This feature can be set independently for each output. The desired value for the brightness (0 – 15) must be added to the value of the corresponding control CV that determines the lighting effects (starting with CV 113, also refer to the table in chapter 21.1).

! Since the adjustment of brightness is achieved by so-called pulse width modulation the voltage at the output terminals remains constant. This adjustment of brightness is therefore not suitable for adjusting the output voltage to suit lamps with lower nominal voltage! It is essential that you refer to chapter 6.7.1.1 for more details!

12.3.3. Digital Couplers

LokPilot V3.0

LokPilot V3.0 DCC

LokPilot XL V3.0

LokPilot Fx V3.0

Some LokPilot decoders can directly control digital couplers. Subject to the type of coupler, you must adjust certain settings.

12.3.3.1. „Pulse“ Mode for Telex®

In order to operate the Märklin® Telex® coupler we have created the „Pulse“ function: the „brightness value“ takes on a special role in this case: the value determines how long a function should remain switched. The „brightness value“ 0 means 0.5 seconds; the value 15 corresponds to about 8 seconds. After this predetermined time, the decoder turns off this function. This prevents overheating the windings of the coupler.

12.3.3.2. „Coupler“ Mode for Krois® and ROCO®

Krois® and ROCO® couplers need a special high frequency PWM signal to avoid burning the copper windings of the coil. This special function „Coupler“ provides this type of signal. In this mode, the output switches on at 100% for 250 ms and then reduces the output power by switching to the PWM-signal. The ratio between Off and On time can be set by adjusting the „Brightness Value“ from 0 (completely off) to 15 (connected through = 100% output). A value of 243 has proven to be a good number for ROCO® couplers (this corresponds with a PWM value of 3).

! This coupler function is only available on outputs AUX1 and AUX2.

12.3.4. Blinker lights

12.3.4.1. Period for Blinker Lights

If you have selected the „Blinker“ or „Inverse Blinker“ mode for an output then the duration of the blinker period (and thus the blinker frequency) is set for all outputs in CV 112.

The blinker period can be set in 63 steps. It is always a multiple of 65.5 milliseconds.

Figure 13: Function mapping - factory default values for LokPilot V3.0

Function-button	Description	Control CV A	Headlight	Back-up lights	AUX 1	AUX 2	AUX 3 (if available)	AUX 4 (if available)	AUX 5 (if available)	AUX 6 (if available)
	vaule		1	2	4	8	16	32	64	128
FS(f)	stand forward	129								
FS(r)	stand backward	132								
FF(f)	drive forward	135								
FF(r)	drive backward	138								
F0	light forward	141	1							
F0	light backward	144		2						
F1	key F1 forward	147			4					
F1	key F1 backward	150			4					
F2	key F2 forward	153				8				
F2	key F2 backward	156				8				
F3	key F3 forward	159								
F3	key F3 backward	162								
F4	key F4 forward	165								
F4	key F4 backward	168								
F5	key F5 forward	171					16			
F5	key F5 backward	174					16			
F6	key F6 forward	177						32		
F6	key F6 backward	180						32		
F7	key F7 forward	183							64	
F7	key F7 backward	186							64	
F8	key F8 forward	189								128
F8	key F8 backward	192								128
F9	key F9 forward	195								
F9	key F9 backward	198								
F10	key F10 forward	201								
F10	key F10 backward	204								
F11	key F11 forward	207								
F11	key F11 backward	210								
F12	key F12 forward	213								
F12	key F12 backward	216								
F13	key F13 forward*	219								
F13	key F13 backward*	222								
F14	key F14 forward*	225								
F14	key F14 backward*	228								
F15	key F15 forward*	231								
F15	key F15 backward*	234								

* except for LokPilot micro V3.0, LokPilot micro V3.0 DCC, LokPilot Fx V3.0

Funct.- Button	Control CV B	Acceleration ON/OFF	Shunting mode On/Off	„Sound“ On / Off						Dynamic brake		
FS(f)	130	1	2	4						128		
FS(r)	133											
FF(f)	136											
FF(r)	139											
F0	142											
F0	145											
F1	148											
F1	151											
F2	154											
F2	157											
F3	160		2									
F3	163		2									
F4	166	1										
F4	169	1										
F5	172											
F5	175											
F6	178											
F6	181											
F7	184											
F7	187											
F8	190											
F8	193											
F9	196											
F9	199											
F10	202											
F10	205											
F11	208											
F11	211											
F12	214											
F12	217											
F13	220											
F13	223											
F14	226											
F14	229											
F15	231											
F15	235											

Function Outputs

12.3.5. Examples for Typical Settings

Example 1: smoke generator on AUX 1 and F5.

Let us assume you want to connect a smoke generator to output AUX1 and activate it with function button F5.

The output AUX1 must be unlocked and allocated to button F5. Firstly, we activate the output and set it to dimmer function (100% continuous output; no flashing, etc.) and the brightness should be 100%. CV 115 is responsible for output AUX1. Calculate the value to be entered in CV 115 as follows: 15 for maximum brightness.

Now you must link the function button F5 with the output AUX1: have a look at Fig. 13: control CV 171 (in the third column) is responsible for F5 Forward. Which functions should be switched with F5 must be entered in CV 171. If you follow the line for F5 in the table in Fig. 13 to the right until it meets the column for AUX1 then you find a number in the header line above.

In our example, the number is „4“. Enter this value into CV 171. Then the F5 button will switch the output AUX1. Thus, the function is programmed for forward travel. Now enter the same values in CV 174 in order to activate the same for travelling in reverse.

Example 2: Blinker beacon on AUX2 and F6.

You want to wire a blinker beacon to AUX2 and allocate it to the F6 button. The brightness should be 6/15 of the maximum brightness. The blinker period and the On / Off ratio must be set as described above. Firstly, we must unlock the output AUX2 and set it to blinker function. We do this in CV 116. In our example we enter the value 16 (for blinker) + 5 (for 6/15 of maximum brightness) = 21.

Then you must link the output AUX2 to the function button F6 with the control CV 177. In CV 177, you enter the functions to be controlled by the F6 button. If you follow the line for F6 Forward in the table in Fig. 13 to the right until it meets the column for AUX2 then you find the number 8 in the header line. You must enter this value in CV 177.

Now the F6 Forward button controls the output AUX2. To set the same for reverse you must enter the value 8 in CV 180.

Example 3: Brake time On / Off with F5.

Here the acceleration and brake time should be activated and turned off with F5. Since acceleration and deceleration are not physical outputs but logical functions, you don't have to configure this function.

All you have to do is allocate the button F5 to the function „Deactivate Brake Time“: enter the value „1“ in CV 172; should this function also be active in reverse, enter the value „1“ in CV 175.

12.4. Analogue Settings

LokPilot V3.0	LokPilot V3.0 DCC	LokPilot V3.0 mfx
LokPilot micro V3.0	LokPilot micro V3.0 DCC	
LokPilot XL V3.0		
LokPilot Fx V3.0		

With the CVs 13 and 14, you can predetermine which function buttons should be switched in analogue mode. Thus, you „simulate“ pressing an F button. The ex works default settings switch on the directional headlights (F0 is on!) as well as F1 (ex works allocated to AUX1).



12.5. LGB® Pulse Sequence Mode

LokPilot V3.0	LokPilot V3.0 DCC
LokPilot micro V3.0	LokPilot micro V3.0 DCC
LokPilot XL V3.0	
LokPilot Fx V3.0	

It is possible to switch to pulse sequence mode for operations with the LGB® command station and the Roco® Lokmaus I. In this mode, the decoder counts the number of times the F1 button is pressed in order to activate the desired function. Thus, it is possible to reach all function buttons by repeated pushing of the F1 button.

12.6. Swiss Headlight Mode

LokPilot V3.0	LokPilot V3.0 DCC
LokPilot micro V3.0	LokPilot micro V3.0 DCC
LokPilot XL V3.0	
LokPilot Fx V3.0	

Function mapping enables you to set many different configurations. The Swiss headlight mode is a good example. We need a third lighting circuit that switches the left lower headlight of the „A“-headlight configuration whenever the lights are turned on. This third circuit must work independently from the direction of travel.

Figure 18 shows one option of how to wire this arrangement with AUX1 (green wire) being used for the third circuit. All you have to do now is to program the decoder in such a way that it always switches on that third circuit when the lighting function is active.

Enter the value 5 in CV 141 and the value 6 in CV 144. That's it!

13. Decoder Reset

You can reset decoder to the default settings at any time.

13.1. With DCC Systems or 6020/6021

Enter the value 08 in CV 08.

13.2. With Märklin® systems (mfx-decoder)

mfx® decoders can be reset to factory default values with the Central Station® or the Mobile Station® via the reset command in the locomotive menu.

13.3. With the ESU LokProgrammer

Enter the value 08 in CV 08 in the option „Read / Write CVs“ in the menu „Edit CVs“.

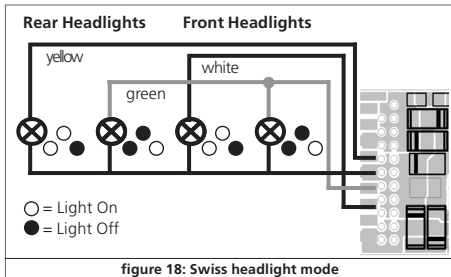

14. Special Functions

You may not yet be aware of some other highly specialised functions offered by LokPilot decoders.

14.1. Directional Bit

The directional bit determines the driving behaviour when transitioning from an analogue into a digital sector (also refer to chapter 10.4.3.). If you want to set this directional bit, then bit 1 in CV 124 must be set.

14.2. Saving the Operating Status

LokPilot decoders can record the current operating status. The decoder will start up / accelerate or continue as programmed after a power interruption. You can store the following data:

Direction of travel:

Saves the direction in Motorola® (old) mode.

Status of functions:

Remembers which functions were on or off and switches them as per the previous status.

Current speed:

If this is set, the locomotive will continue with exactly that speed after a power interruption regardless of the commands transmitted from the command station.

Accelerate with delay as per CV 3:

Use this with in conjunction with the previous option: if this option is set, then the locomotive will accelerate (as programmed in CV 3) after a power interruption. If this option is not set, then the locomotive will attempt to reach the previous speed as quickly as possible. We recommend turning off this option since it overrules the effects of the programmed acceleration. This option is actually only intended for operation with the 6020 since the 6020 does not transmit any commands after being switched on. The default setting records the direction, the status of the functions and the current speed.

LokPilot V3.0	LokPilot V3.0 DCC	

- The decoder can detect the duration of a power interruption:
- If the power interruption is shorter than 2 seconds the decoder assumes a poor contact and will try to reach the previous speed as quickly as possible provided the feature „Current Speed“ has been set.
 - If the interruption takes longer, then the decoder assumes to be in a brake sector (perhaps ahead of a red signal) with intentional power cut-off. As soon as this sector receives power again, the decoder will accelerate as per the settings in CV 3.

15. Multiple traction with LokSound Locomotives

LokPilot V3.0	LokPilot V3.0 DCC	
LokPilot micro V3.0	LokPilot micro V3.0 DCC	
LokPilot XL V3.0		

At times one would like to use multiple headers for a train made up of locomotives with LokSound decoders and others with LokPilot decoders. The problem is that the locomotive with the LokPilot will start moving immediately while the one with the LokSound decoder remains stationary until the engine (the diesel sound) has revved up.

To avoid this you can activate „Acceleration Delay“ in the LokPilot V3.0 with CV 253. Acceleration will only commence after the time programmed in CV 253. Fine-tune the performance of both (or all) decoders by testing their behaviour.



The LokSound decoder delays acceleration only if the sound is turned on. Therefore, the LokPilot decoder must also „know“ if



the sound is turned on or off. For that reason, LokPilot decoders also support the function „Sound On / Off“. Of course, this is a fictitious function only. Via this virtual function, the LokPilot can find out if the sound is actually switched on in the LokSound decoder and delay departure if necessary. Therefore, you must allocate the function „Sound On / Off“ in the function mapping of the LokPilot decoder as well as in the LokSound decoder.



The factory default setting for turning on the sound in LokSound decoders is „F1“.

Write in CV 148 = 4 and CV 151 = 4.

16. RailCom®

LokPilot V3.0

LokPilot V3.0 DCC

LokPilot micro V3.0

LokPilot micro V3.0 DCC

LokPilot XL V3.0

LokPilot Fx V3.0

RailCom® was developed by Lenz Elektronik, Giessen and is a technology for transmitting information from the decoder back to the command station. Until now DCC, systems could only transmit data from the command station to the decoder but could never be sure if the decoder actually received the commands.

The locomotive can send the following information to the command station:

Locomotive address: the decoder transmits its address on request by „Broadcast“. Detectors in a certain track sector can detect this command. Thus, the command station can find out the location of that particular locomotive.

CV information: the decoder can provide feedback about all CV values to the command station per RailCom®. In future, a programming track will not be necessary any more.

Meta data: the decoder can transmit status information such as motor load, current draw of the motor, temperature etc. to the command station.



In order for RailCom® to work all decoders and the command station must be equipped accordingly. LokPilot decoders are RailCom®-ready in terms of their hardware. However, it may be necessary to carry out a firmware update in order to activate it. Relevant information regarding the status of the implementation of RailCom® is available on our homepage.



Prior to use RailCom® must be unlocked by setting bit 3 in CV 29. CV 28 offers further options. Ex works, RailCom® is not active in ESU decoders.

17. Firmware Update

You can update LokPilot decoders with new operating software (so-called firmware) at any time. This is useful for fixing bugs and implementing new functions.

You can carry out the update yourself without having to remove the decoder from the locomotive. All you need is the ESU LokProgrammer. The most recent version of the firmware can be downloaded free of charge from our website.

We never treat updates carried out by our service department as warranty service but will charged you. Please inquire about the cost on our website before you send in a decoder.



Only change the firmware if you want to fix bugs that are relevant to you or if you want to introduce new essential functions. Otherwise, never change the configuration of a system that works reliably.

18. Accessories

You will get detailed information regarding accessories at your dealer or on our homepage.

18.1. Switching the Centre pick-up

The circuit board 51966 for switching the centre pick-up only for the decoder with the 21MTC interface is intended for vehicles with two pick-ups. Thus, you can activate the forward pick-up in the direction of movement. This is ideal for block control!

18.2. HAMO Magnets

One cannot drive the universal motors in many Märklin® models directly with a LokPilot decoder. Firstly, you must replace the stator coil with a permanent magnet. ESU supplies the following magnets:

51960	Permanent magnet as 220560, for rotor 217450, D=24.5 mm, for motor plate 216730, 211990, 228500
51961	Permanent magnet as 220450, for rotor 200680, D=18.0 mm, for motor plate 204900
51962	Permanent magnet as 235690, for rotor 231440, D=18.0 mm, for motor plate 231350

18.3. Wire Harnesses with 8-pole or 6-pole Socket

If the locomotive you want to convert does not have an interface and you do not want to remove the plug from the decoder then you can use the harness 51950 or 51951: first install the suitable harness and then plug in the decoder.

18.5. Mounting Adapter 21MTC

If you wish to convert a locomotive with a LokPilot decoder with the 21MTC interface, the adapter plate 51967 comes in handy: it has a socket for plugging in the LokPilot but also has solder points for connecting the original wiring of the locomotive. This is ideal for converting Märklin locomotives.

19. Support and assistance

Your model train dealer or hobby shop is your competent partner for all questions regarding your LokPilot decoder. In fact he is your competent partner for all questions around model trains. Of course, you may also contact us directly. For enquiries please use either email or fax (don't forget to provide your own fax-no. or email address) and we will reply within a few days.

Please call our hotline only in case of complex enquiries that can't be dealt with by email or fax. The hotline is often very busy and you may encounter delays. Rather send an email or fax and also check our website for more information. You will find many hints under "Support / FAQ" and even feedback from other users that may help you with your particular question.

Of course we will always assist you; please contact us at:

by phone: ++001 (0) 320 – 5 73 43 00 (US)
++49 (0) 700 – 56 57 68 63 (Germany)
Tuesday & Wednesday

from 10:00am till 12:00am

by fax: ++001 (0) 320 – 5 73 27 00 (US)
++49 (0) 700 – 37 87 25 37 (Germany)

email: support@loksound.de

snail mail: ESU GmbH & Co. KG | ESU LLC
- technical support - PO Box 77
Industriestraße 5 Upsala MN 56384
D-89081 Ulm U.S.A.
Germany www.loksound.com

www.esu.eu

20. Technical Data

	LokPilot micro V3.0	LokPilot micro V3.0 DCC	LokPilot V3.0	LokPilot V3.0 DCC	LokPilot V3.0 mfx	LokPilot XL V3.0	LokPilot Fx V3.0
Operation Voltage	5 – 25V	5 – 25V	5 – 40V	5 – 27V	5 – 40V	5 – 40V	5 – 40V
DCC operation using 14/28/128 Fahrstufen, 2-digit and 4-digit addresses; automatic recognition of operational mode	Ok	Ok	Ok	Ok	-	Ok	Ok
Motorola® (old & new), with 14/28 speed steps address range for Motorola®-mode	Ok 127	-	Ok 127	-	Ok 255	Ok 127	Ok 127
mfx®-operation with automatic recognition	-	-	-	-	Ok	-	-
Selectrix®-operation	Ok	-	Ok	-	-	Ok	-
Analog DC Operation	Ok	Ok	Ok	Ok	-	Ok	Ok
Analog AC Operation	-	-	Ok	-	Ok	Ok	Ok
DCC-programming (direct, page, register-mode)	Ok	Ok	Ok	Ok	-	Ok	Ok
Motorola®-Programming mode using 6021, Mobile Station, or Central Station	-	-	Ok	-	Ok	Ok	Ok
mfx®-Programming procedure	-	-	-	-	Ok	-	-
Märklin® brake section	Ok	-	Ok	-	Ok	Ok	Ok
Brake on DC, Roco brake section	Ok	Ok	Ok	Ok	-	Ok	Ok
Selectrix® brake mode (with diodes)	Ok	-	Ok	-	-	Ok	-
Shunting mode	Ok	Ok	Ok	Ok	Ok	Ok	-
RailCom® Option (by Firmwareupgrade)	-	Ok	Ok	Ok	-	Ok	Ok
Continuous motor load	0.75A	0.75A	1.1A	1.1A	1.1A	3.0A	-
4th generation back-EMF control , overload protected	16/32 kHz	16/32 kHz	16/32 kHz	16/32 kHz	16/32 kHz	16/32 kHz	-
Number of Function outputs	2 / 140mA	2 / 140mA	4 / 250 mA	4 / 250mA	4 / 250mA	8 / 600mA	6 / 250mA
Total loa of all function outputs	280mA	280mA	500mA	500mA	500mA	2000mA	500mA
Supported function keys (mappable)	F0 - F12	F0 - F12	F0 - F15	F0 - F15	F0 - F15	F0 - F15	F0 - F12
Integrated PowerPack backup capacitor	-	-	-	-	-	Ok	-
Dimensions in mm:	13,5x9,0x3,0	13,5x9,0x3,0	23,5x15,5x5,5	23,5x15,5x5,5	23,5x15,5x5,5	64x25x11,5	17,5x15,5x5,5

List of all supported CVs

21.1. DCC Decoders

On the following pages, we have listed all CVs of LokPilot decoders in a table. Please refer to the CV concept as outlined in chapter 5.1.



Please only change CVs if you are certain about their purpose and the impact of your action. Wrong CV settings can lead to impaired performance or may cause your LokPilot not to respond at all.

CV	Name	Description	Range	Def.																											
1	primary address	Address of engine (For LokPilot V3.0, LokPilot XL V3.0: Ragne = 1 - 255)	1 – 127	3																											
2	Start voltage*	Sets the minimum speed of the engine	1 – 75	3																											
3	Acceleration	This value multiplied by 0.869 is the time from stop to maximum speed	0 – 64	8																											
4	Decelearation	This value multiplied by 0.869 is the time from maximum speed to stop (=brake time)	0 – 64	6																											
5	Maximum speed*	Maximum speed of the engine	0 - 64	64																											
6	Medium speed*	Medium speed of engine	0 - 64	22																											
7	Version number	Internal software version of LokPilot decoder	-	-																											
8	Manufacturer's ID	Manufacturers's ID - ESU - Writing value 8 in this CV triggers a reset to factory default values		151																											
13	Analogue mode F1-F8	Status of functions F1 to F8 in analogue mode	0-255	1																											
		<table border="1"> <thead> <tr> <th>Bit</th> <th>Function</th> <th>value</th> </tr> </thead> <tbody> <tr> <td>0</td> <td>Function F1</td> <td>1</td> </tr> <tr> <td>1</td> <td>Function F2</td> <td>2</td> </tr> <tr> <td>2</td> <td>Function F3</td> <td>4</td> </tr> <tr> <td>3</td> <td>Function F4</td> <td>8</td> </tr> <tr> <td>4</td> <td>Function F5</td> <td>16</td> </tr> <tr> <td>5</td> <td>Function F6</td> <td>32</td> </tr> <tr> <td>6</td> <td>Function F7</td> <td>64</td> </tr> <tr> <td>7</td> <td>Function F8</td> <td>128</td> </tr> </tbody> </table>	Bit	Function	value	0	Function F1	1	1	Function F2	2	2	Function F3	4	3	Function F4	8	4	Function F5	16	5	Function F6	32	6	Function F7	64	7	Function F8	128		
Bit	Function	value																													
0	Function F1	1																													
1	Function F2	2																													
2	Function F3	4																													
3	Function F4	8																													
4	Function F5	16																													
5	Function F6	32																													
6	Function F7	64																													
7	Function F8	128																													
		* not for LokPilot Fx V3.0																													

CV	Name	Description	Range	Def.		
14	Analogue mode FL, F9-F12	Status of function FL, F9 to F12 in analogue mode	0-255	3		
		Bit			Function	value
		0			Function FL(f)	1
		1			Function FL(r)	2
		2			Function F9(f)	4
		3			Function F10 (f)	8
		4			Function F11	16
		5			Function F12	32
6	Function F9(r)	64				
7	Function F10 (r)	128				
17 18	Extended engine address	long addrss of engine CV CV 17 contains the byte with higher value (bit 6 and bit 7 must be, always active), CV18 contains the byte with the lower value. Only active, when function is enabled using CV 29 (see below)	128.- 9999	192		
19	Consist address	Additional address for consist operation. Value 0 or 128 means: consist address ist disabled 1 – 127 consist address active, normal direction 129 – 255 consist address active, reverse direction	0-255	0		
21	Consist mode F1-F8	Status of functions F1 to F8 in Consist mode	0-255	0		
		Bit			Function	Value
		0			Function F1	1
		1			Function F2	2
		2			Function F3	4
		3			Function F4	8
		4			Function F5	16
		5			Function F6	32
6	Function F7	64				
7	Function F8	128				

List of all supported CVs

CV	Name	Description	Range	Value		
22	Consist Mode FL, F9-F12	Status of functions FL, F9 to F12 in Consist mode		0-255	0	
		Bit	Function			Value
		0	Function FL(f)			1
		1	Function FL(r)			2
		2	Function F9(f)			4
		3	Function F10(f)			8
		4	Function F11			16
		5	Function F12			32
6	Function F9(r)	64				
7	Function F10(r)	128				
28	RailCom Configuration	Settings for RailCom		2		
		Bit	Function			Value
		0	Channel 1 Address broadcast			0
			Channel 1 Address broadcast disabled			
			Channel 1 Address broadcast enabled			
1	Data transmission on Channel 2	0				
	No data transmission allowed on Channel 2 data transmission allowed on Channel 2					
2	Command Acknowledgement on Channel 1	0				
	No command Acknowledgement on Channel 1 (disabled) Command Acknowledgement on Channel 1 allowed (enabled)					

CV	Name	Description	Range	Value	
29	Configuration register	The most complex CV within the DCC standards. This register contains important information, some of which are only relevant for DCC operation		4	
		Bit	Function		Value
		0	Reverse direction of travel (forward becomes reverse) Normal direction Reversed direction		0 1
		1	Speed steps (For DCC-operation only) 14 speed steps 28 or 128 speed steps		0 2
		2	analog operation Disable analog operation (no function on conventional layout) Enable analog operation		0 4
		3	RailCom communication Disable RailCom Enable RailCom		0 8
		4	Selection of speed curve speed curve through CV 2, 5, 6 speed curve through CV 67 - 96		0 16
		5	Selection of engine address (only for DCC operation) short addresses (CV 1) in DCC mode long addresses (CV 17+CV18) in DCC mode		0 32

List of all supported CVs

CV	Name	Description	Range	Value		
49	Extended Configuration	Additional important settings for LokPilot Decoders		0 - 255	19	
		Bit	Description			Value
		0	Enable Load control (Back-EMF) (not for LokPilot Fx V3.0) Disable Load control (Back-EMF)			1 0
		1	Motor PWM frequency 16 kHz motor pulse frequency 32 kHz motor pulse frequency			0 2
		2	Märklin Delta Mode Disable Märklin Delta Mode (Headlights controlled by command station) Enable Märklin Delta Mode (Headlights are always ON)			0 4
		3	Märklin 2. Adresse Märklin 2. Adresse Disable Märklin 2. Adresse Enable			0 8
		4	Automatic DCC speed step detection Disable DCC speed step detection Enable DCC speed step detection			0 16
		5	LGB function button mode (sequential LGB functions) Disable LGB function button mode Enable LGB function button mode			0 32
		6	Zimo Manual Function Disable Zimo Manual Function Enable Zimo Manual Function			0 64

CV	Name	Description	Range	Value	
50	Analogue mode	Selection of allowed analogue modes		0-3 3	
		Bit	Function		Value
		0	AC Analogue Mode (if implemented. Please refer to section 7.3.) Disable AC Analog Mode Enable AC Analog Mode		0 1
		1	DC Analogue mode Disable DC Analogue mode Enable DC Analogue Mode		0 2
51	Brake modes	Selection of desired (allowed) brake modes		3	
		Bit	Function		Value
		0	Märklin brake mode Disable Märklin brake mode Enable Märklin brake mode		0 1
		1	Zimo brake mode (will eventually not work on all ZIMO layouts) Disable Zimo brake mode Enable Zimo brake mode		0 2
		2	reserved		
3	Lenz DC brake mode (brake-on-DC) Disable Lenz brake mode Enable Lenz brake mode	0 8			
53	Control Reference voltage (not for LokPilot Fx)	Defines the Back EMF voltage, which the motor should generate at maximum speed. The higher the efficiency of the motor, the higher this value may be set. If the engine does not reach maximum speed, reduce this parameter	0 - 80	56	
54	Load Control parameter „K“ (not for LokPilot Fx)	„K“-component of the internal PI-controller. Defines the effect of load control. The higher the value, the stronger the effect of Back EMF control	0 - 80	32	
55	Load Control parameter „I“ (not for LokPilot Fx)	„I“-component of the internal PI-controller. Defines the momentum (inertia) of the motor. The higher the momentum of the motor (large flywheel or bigger motor diameter, the lower this value has to be set.	0 - 80	24	

List of all supported CVs

CV	Name	Description	Range	Value																								
56	Operating range of load control (not for LokPilot Fx)	0 – 100 % Defines up to which speed in % load control will be active. A value of 32 indicates that load control will be effective up to half speed.	1 - 64	64																								
66	Forward Trimm (not for LokPilot Fx)	Divided by 128 is the factor used to multiply the motor voltage when driving forward. The value 0 deactivates the trim.	0 - 255	0																								
67-94	Speed table	Defines motor voltage for speed steps. The values „in between“ will be interpolated.	0 – 255	—																								
95	Reverse Trimm (not for LokPilot Fx)	Divided by 128 is the factor used to multiply the motor voltage when driving backwards. Value 0 deactivates the trim.	0 - 255	0																								
112	Blinking light	Blinking frequency of Strobe effects. Always a multiple of 65.536 milliseconds.	4 - 64	33																								
113	Headlight configuration	Configurations of headlights	0 – 255	15																								
		<table border="1"> <thead> <tr> <th>Description</th> <th>Value</th> </tr> </thead> <tbody> <tr> <td>Continuous (dimmer)</td> <td>Vol</td> </tr> <tr> <td>blinking (Phase 1)</td> <td>Vol + 16</td> </tr> <tr> <td>blinking (Phase 2)</td> <td>Vol + 32</td> </tr> <tr> <td>Strobe light</td> <td>Vol + 48</td> </tr> <tr> <td>Double Strobe light</td> <td>Vol + 64</td> </tr> <tr> <td>Fire box</td> <td>Vol + 80</td> </tr> <tr> <td>Smoke generator</td> <td>Vol + 96</td> </tr> <tr> <td>Headlight bright/dim</td> <td>Vol + 112</td> </tr> <tr> <td>Marslight</td> <td>Vol + 128</td> </tr> <tr> <td>Gyrolight</td> <td>Vol + 144</td> </tr> <tr> <td>„Rule 17“ for head light</td> <td>Vol + 160</td> </tr> <tr> <td>„Rule 17“ for rear light</td> <td>Vol + 176</td> </tr> <tr> <td>Output „Pulse“ (time-restricted)</td> <td>Vol + 192</td> </tr> </tbody> </table>			Description	Value	Continuous (dimmer)	Vol	blinking (Phase 1)	Vol + 16	blinking (Phase 2)	Vol + 32	Strobe light	Vol + 48	Double Strobe light	Vol + 64	Fire box	Vol + 80	Smoke generator	Vol + 96	Headlight bright/dim	Vol + 112	Marslight	Vol + 128	Gyrolight	Vol + 144	„Rule 17“ for head light	Vol + 160
Description	Value																											
Continuous (dimmer)	Vol																											
blinking (Phase 1)	Vol + 16																											
blinking (Phase 2)	Vol + 32																											
Strobe light	Vol + 48																											
Double Strobe light	Vol + 64																											
Fire box	Vol + 80																											
Smoke generator	Vol + 96																											
Headlight bright/dim	Vol + 112																											
Marslight	Vol + 128																											
Gyrolight	Vol + 144																											
„Rule 17“ for head light	Vol + 160																											
„Rule 17“ for rear light	Vol + 176																											
Output „Pulse“ (time-restricted)	Vol + 192																											
		Vol = brightness. Range 0 (dark) - 15 (maximum)																										

CV	Name	Description	Range	Value	
114	Back-up light configuration	Configuration of back-up lights	0 - 255	15	
		Description			Value
		continuous (dimmer)			Vol
		blinking (Phase 1)			Vol + 16
		blinking (Phase 2)			Vol + 32
		Strobe light			Vol + 48
		Double Strobe light			Vol + 64
		Fire box			Vol + 80
		Smoke generator			Vol + 96
		Headlight bright/dim			Vol + 112
		Marslight			Vol + 128
Gyrolight	Vol + 144				
„Rule 17“ for head light	Vol + 160				
„Rule 17“ for rear light	Vol + 176				
Output „Pulse“ (time-restricted)	Vol + 192				
		Vol = brightness. Range 0 (dark) - 15 (maximum)			
115	AUX 1 configuration	Configuration of output „AUX 1“	0 - 255	15	
		Description			Value
		continuous (dimmer)			Vol
		blinking (Phase 1)			Vol + 16
		blinking (Phase 2)			Vol + 32
		Strobe light			Vol + 48
		Double Strobe light			Vol + 64
		Fire box			Vol + 80
		Smoke generator			Vol + 96
		Headlight bright/dim			Vol + 112
		Marslight			Vol + 128
Gyrolight	Vol + 144				
„Rule 17“ for head light	Vol + 160				
„Rule 17“ for rear light	Vol + 176				
Output „Pulse“ (time-restricted)	Vol + 192				
Output digital coupler (see for details chapter 12.3.3.2.)	Vol + 240				
		Vol = bightness. Range 0 (dark) - 15 (maximum)			

List of all supported CVs

CV	Name	Description	Range	Value	
116	AUX 2 configuration	Configuration of output „AUX 2“	0 - 255	15	
		Description			Value
		continuous (dimmer)			Vol
		blinking (Phase 1)			Vol + 16
		blinking (Phase 2)			Vol + 32
		Strobe light			Vol + 48
		Double Strobe light			Vol + 64
		Fire box			Vol + 80
		Smoke generator			Vol + 96
		Headlight bright/dim			Vol + 112
		Marslight			Vol + 128
Gyrolight	Vol + 144				
„Rule 17“ for head light	Vol + 160				
„Rule 17“ for rear light	Vol + 176				
Output „Pulse“ (time-restricted)	Vol + 192				
Output digital coupler (see for details chapter 12.3.3.2.)	Vol + 240				
		Vol = bightness. Range 0 (dark) - 15 (maximum)			
117	AUX 3 configuration LokSound XL only	Configuration of output „AUX 3“	0 - 255	15	
		Description			Value
		continuous (dimmer)			Vol
		blinking (Phase 1)			Vol + 16
		blinking (Phase 2)			Vol + 32
		Strobe light			Vol + 48
		Double Strobe light			Vol + 64
		Fire box			Vol + 80
		Smoke generator			Vol + 96
		Headlight bright/dim			Vol + 112
		Marslight			Vol + 128
Gyrolight	Vol + 144				
„Rule 17“ for head light	Vol + 160				
„Rule 17“ for rear light	Vol + 176				
Output „Pulse“ (time-restricted)	Vol + 192				
		Vol = bightness. Range 0 (dark) - 15 (maximum)			

CV	Name	Description	Range	Value	
118	AUX 4 configuration (LokPilot XL only)	Configuration of output „AUX 4“	0 - 255	15	
		Description			Value
		continuous (dimmer)			Vol
		blinking (Phase 1)			Vol + 16
		blinking (Phase 2)			Vol + 32
		Strobe light			Vol + 48
		Double Strobe light			Vol + 64
		Fire box			Vol + 80
		Smoke generator			Vol + 96
		Headlight bright/dim			Vol + 112
		Marslight			Vol + 128
		Gyrolight			Vol + 144
		„Rule 17“ for head light			Vol + 160
„Rule 17“ for rear light	Vol + 176				
Output „Pulse“ (time-restricted)	Vol + 192				
Vol = brightness. Range 0 (dark) - 15 (maximum)					
119	AUX 5 configuration (LokPilot XL only)	Configuration of output „AUX 5“	0 - 255	15	
		Description			Value
		continuous (dimmer)			Vol
		blinking (Phase 1)			Vol + 16
		blinking (Phase 2)			Vol + 32
		Strobe light			Vol + 48
		Double Strobe light			Vol + 64
		Fire box			Vol + 80
		Smoke generator			Vol + 96
		Headlight bright/dim			Vol + 112
		Marslight			Vol + 128
		Gyrolight			Vol + 144
		„Rule 17“ for head light			Vol + 160
„Rule 17“ for rear light	Vol + 176				
Output „Pulse“ (time-restricted)	Vol + 192				
Vol = brightness. Range 0 (dark) - 15 (maximum)					

List of all supported CVs

CV	Name	Description	Range	Value	
120	AUX 6 configuration (LokPilot XL only)	Configuration of output „AUX 6“	0 - 255	15	
		Description			Value
		continuous (dimmer)			Vol
		blinking (Phase 1)			Vol + 16
		blinking (Phase 2)			Vol + 32
		Strobe light			Vol + 48
		Double Strobe light			Vol + 64
		Fire box			Vol + 80
		Smoke generator			Vol + 96
		Headlight bright/dim			Vol + 112
Marslight	Vol + 128				
Gyrolight	Vol + 144				
„Rule 17“ for head light	Vol + 160				
„Rule 17“ for rear light	Vol + 176				
Output „Pulse“ (time-restricted)	Vol + 192				
		Vol = bightness. Range 0 (dark) - 15 (maximum)			
124	Auxiliary settings	Controls auxiliary settings of the LokSound decoder		6	
		Description	Value		
		Store direction (Motorola®)	1		
		Store function state	2		
		Store current speed setting	4		
		Start again with acceleration ramp	8		
		No emergency stop during direction switch for Motorola operation	16		
		No PWM in analog operation	64		
		No PWM for function outputs for analog operation (interconnection)	128		
125	Voltage of engine Analog DC	(not for LokPilot Fx V3.0)	0-127	15	
126	Maximum speed Analog DC	(not for LokPilot Fx V3.0)	0-127	45	
127	Voltage of engine Analog AC	(not for LokPilot micro V3.0, LokPilot micro V3.0 DCC, LokPilot Fx V3.0)	0-127	15	
128	Maximum speed Analog AC	(not for LokPilot micro V3.0, LokPilot micro V3.0 DCC, LokPilot Fx V3.0)	0-127	45	

CV	Name	Description	Range	Value				
129	Assignment of function button „Stop“ Forward A	Assignment of function outputs that are activated in status „stop-forward“	0 – 255	0				
		Bit Description Value						
		0 headlights 1						
		1 back-up lights 2						
		2 function output AUX 1 4						
		3 function output AUX 2 8						
		4 function output AUX 3 (if available) 16						
		5 function output AUX 4 (if available) 32						
6 function output AUX 5 (if available) 64								
7 function output AUX 6 (if available) 128								
130	Assignment of function button „Stop“ Forward B	Assignment of function outputs that are activated in status „stop-forward“	0 – 255	0				
		Bit Description Value						
		0 acceleration on / off 1						
		1 shunting mode on / off 2						
		2 sound on / off 4						
		7 Dynamic brake 128						
		132			Assignment of function button „Stop“ back-up A	Assignment of function outputs that are activated in status „stop-back-up“	0 - 255	0
						Bit Description Value		
0 headlights 1								
1 back-up lights 2								
2 function output AUX 1 4								
3 function output AUX 2 8								
4 function output AUX 3 (if available) 16								
5 function output AUX 4 (if available) 32								
6 function output AUX 5 (if available) 64								
7 function output AUX 6 (if available) 128								
133	Assignment of function button „Stop“ back-up B	Assignment of function outputs that are activated in status „stop-back-up“	0 - 255	0				
		Bit Description Value						
		0 acceleration on / off 1						
		1 shunting mode on / off 2						
		2 sound on / off 4						
		7 Dynamic brake 128						

List of all supported CVs

CV	Name	Description	Range	Value				
135	Assignment of function button „Running“ forward A	Assignment of function outputs that are activated in status „running-forward“	0 - 255	0				
		Bit Description Value						
		0 headlights 1						
		1 back-up lights 2						
		2 function output AUX 1 4						
		3 function output AUX 2 8						
		4 function output AUX 3 (if available) 16						
		5 function output AUX 4 (if available) 32						
6 function output AUX 5 (if available) 64								
7 function output AUX 6 (if available) 128								
136	Assignment of function button „Running“ forward B	Assignment of function outputs that are activated in status „running-forward“	0 - 255	0				
		Bit Description Value						
		0 acceleration on / off 1						
		1 shunting mode on / off 2						
		2 sound on / off 4						
		7 Dynamic brake 128						
		138			Assignment of function button „Running“ back-up A	Assignment of function outputs that are activated in status „running-back-up“	0 - 255	0
						Bit Description Value		
0 headlights 1								
1 back-up lights 2								
2 function output AUX 1 4								
3 function output AUX 2 8								
4 function output AUX 3 (if available) 16								
5 function output AUX 4 (if available) 32								
6 function output AUX 5 (if available) 64								
7 function output AUX 6 (if available) 128								
139	Assignment of function button „Running“ back-up B	Assignment of function outputs that are activated in status „running-back-up“	0 - 255	0				
		Bit Description Value						
		0 acceleration on / off 1						
		1 shunting mode on / off 2						
		2 sound on / off 4						
		7 Dynamic brake 128						

CV	Name	Description	Range	Value
141	Assignment of function button headlight forward A	Assignment of function outputs that are activated in status „headlight-forward“	0 - 255	1
		Bit Description Value		
		0 headlights 1		
		1 back-up lights 2		
		2 function output AUX 1 4		
		3 function output AUX 2 8		
		4 function output AUX 3 (if available) 16		
		5 function output AUX 4 (if available) 32		
6 function output AUX 5 (if available) 64				
7 function output AUX 6 (if available) 128				
142	Assignment of function button headlight forward B	Assignment of function outputs that are activated in status „headlight-forward“	0 - 255	0
		Bit Description Value		
		0 acceleration on / off 1		
		1 shunting mode on / off 2		
		2 sound on / off 4		
7 Dynamic brake 128				
144	Assignment of function button headlight reverse A	Assignment of function outputs that are activated in status „headlight-reverse“	0 - 255	2
		Bit Description Value		
		0 headlights 1		
		1 back-up lights 2		
		2 function output AUX 1 4		
		3 function output AUX 2 8		
		4 function output AUX 3 (if available) 16		
		5 function output AUX 4 (if available) 32		
6 function output AUX 5 (if available) 64				
7 function output AUX 6 (if available) 128				
145	Assignment of function button headlight reverse B	Assignment of function outputs that are activated in status „headlight-reverse“	0 - 255	0
		Bit Description Value		
		0 acceleration on / off 1		
		1 shunting mode on / off 2		
		2 sound on / off 4		
7 Dynamic brake 128				

List of all supported CVs

CV	Name	Description	Range	Value				
147	Assignment of function button F1 Forward A	Assignment of function outputs that are activated in status „F1- forward“	0 - 255	4				
		Bit			Description	Value		
		0			headlights	1		
		1			back-up lights	2		
		2			function output AUX 1	4		
		3			function output AUX 2	8		
		4			function output AUX 3 (if available)	16		
		5			function output AUX 4 (if available)	32		
6	function output AUX 5 (if available)	64						
7	function output AUX 6 (if available)	128						
148	Assignment of function button F1 Forward B	Assignment of function outputs that are activated in status „F1- forward“	0 - 255	0				
		Bit			Description	Value		
		0			acceleration on / off	1		
		1			shunting mode on / off	2		
		2			sound on / off	4		
		7			Dynamic brake	128		
		150			Assignment of function button F1 Reverse A	Assignment of function outputs that are activated in status „F1- reverse“	0 - 255	4
						Bit		
0	headlights		1					
1	back-up lights		2					
2	function output AUX 1		4					
3	function output AUX 2		8					
4	function output AUX 3 (if available)		16					
5	function output AUX 4 (if available)		32					
6	function output AUX 5 (if available)	64						
7	function output AUX 6 (if available)	128						
151	Assignment of function button F1 Reverse B	Assignment of function outputs that are activated in status „F1- reverse“	0 - 255	0				
		Bit			Description	Value		
		0			acceleration on / off	1		
		1			shunting mode on / off	2		
		2			sound on / off	4		
		7			Dynamic brake	128		

CV	Name	Description	Range	Value
153	Assignment of function button F2 forward A	Assignment of function outputs that are activated in status „F2 - forward“ refer to CV 129	0 - 255	8
154	Assignment of function button F2 forward B	Assignment of function outputs that are activated in status „F2 - forward“ refer to CV 130	0 - 255	0
156	Assignment of function button F2 reverse A	Assignment of function outputs that are activated in status „F2 - reverse“ refer to CV 129	0 - 255	8
157	Assignment of function button F2 reverse B	Assignment of function outputs that are activated in status „F2 - reverse“ refer to CV 130	0 - 255	0
159	Assignment of function button F3 forward A	Assignment of function outputs that are activated in status „F3 - forward“ refer to CV 129	0 - 255	0
160	Assignment of function button F3 forward B	Assignment of function outputs that are activated in status „F3 - forward“ refer to CV 130	0 - 255	2
162	Assignment of function button F3 reverse A	Assignment of function outputs that are activated in status „F3 - reverse“ refer to CV 129	0 - 255	0
163	Assignment of function button F3 reverse B	Assignment of function outputs that are activated in status „F3 - reverse“ refer to CV 130	0 - 255	2
165	Assignment of function button F4 forward A	Assignment of function outputs that are activated in status „F4 - forward“ refer to CV 129	0 - 255	0
166	Assignment of function button F4 forward B	Assignment of function outputs that are activated in status „F4 - forward“ refer to CV 130	0 - 255	4
168	Assignment of function button F4 reverse A	Assignment of function outputs that are activated in status „F4 - reverse“ refer to CV 129	0 - 255	0
169	Assignment of function button F4 reverse B	Assignment of function outputs that are activated in status „F4 - reverse“ refer to CV 130	0 - 255	4
171	Assignment of function button F5 forward A	Assignment of function outputs that are activated in status „F5 - forward“ refer to CV 129	0 - 255	0

List of all supported CVs

CV	Name	Description	Range	Value
172	Assignment of function button F5 Forward B	Assignment of function outputs that are activated in status „F5 - forward“ refer to CV 130	0 - 255	0
174	Assignment of function button F5 Reverse A	Assignment of function outputs that are activated in status „F5 - reverse“ refer to CV 129	0 - 255	0
175	Assignment of function button F5 Reverse B	Assignment of function outputs that are activated in status „F5 - reverse“ refer to CV 130	0 - 255	0
177	Assignment of function button F6 Forward A	Assignment of function outputs that are activated in status „F6 - forward“ refer to CV 129	0 - 255	0
178	Assignment of function button F6 Forward B	Assignment of function outputs that are activated in status „F6 - forward“ refer to CV 130	0 - 255	0
180	Assignment of function button F6 Reverse A	Assignment of function outputs that are activated in status „F6 - reverse“ refer to CV 129	0 - 255	0
181	Assignment of function button F6 Reverse B	Assignment of function outputs that are activated in status „F6 - reverse“ refer to CV 130	0 - 255	0
183	Assignment of function button F7 Forward A	Assignment of function outputs that are activated in status „F7 - forward“ refer to CV 129	0 - 255	0
184	Assignment of function button F7 Forward B	Assignment of function outputs that are activated in status „F7 - forward“ refer to CV 130	0 - 255	0
186	Assignment of function button F7 Reverse A	Assignment of function outputs that are activated in status „F7 - reverse“ refer to CV 129	0 - 255	0
187	Assignment of function button F7 Reverse B	Assignment of function outputs that are activated in status „F7 - reverse“ refer to CV 130	0 - 255	0
189	Assignment of function button F8 Forward A	Assignment of function outputs that are activated in status „F8 - forward“ refer to CV 129	0 - 255	0
190	Assignment of function button F8 Forward B	Assignment of function outputs that are activated in status „F8 - forward“ refer to CV 130	0 - 255	0

CV	Name	Description	Range	Value
192	Assignment of function button F8 Reverse A	Assignment of function outputs that are activated in status „F8 - reverse“ refer to CV 129	0 - 255	0
193	Assignment of function button F8 Reverse B	Assignment of function outputs that are activated in status „F8 - reverse“ refer to CV 130	0 - 255	0
195	Assignment of function button F9 Forward A	Assignment of function outputs that are activated in status „F9 - forward“ refer to CV 129	0 - 255	0
196	Assignment of function button F9 Forward B	Assignment of function outputs that are activated in status „F9 - forward“ refer to CV 130	0 - 255	0
198	Assignment of function button F9 Reverse A	Assignment of function outputs that are activated in status „F9 - reverse“ refer to CV 129	0 - 255	0
199	Assignment of function button F9 Reverse B	Assignment of function outputs that are activated in status „F9 - reverse“ refer to CV 130	0 - 255	0
201	Assignment of function button F10 Forward A	Assignment of function outputs that are activated in status „F10 - forward“ refer to CV 129	0 - 255	0
202	Assignment of function button F10 Forward B	Assignment of function outputs that are activated in status „F10 - forward“ refer to CV 130	0 - 255	0
204	Assignment of function button F10 Reverse A	Assignment of function outputs that are activated in status „F10 - reverse“ refer to CV 129	0 - 255	0
205	Assignment of function button F10 Reverse B	Assignment of function outputs that are activated in status „F10 - reverse“ refer to CV 130	0 - 255	0
207	Assignment of function button F11 Forward A	Assignment of function outputs that are activated in status „F11 - forward“ refer to CV 129	0 - 255	0
208	Assignment of function button F11 Forward B	Assignment of function outputs that are activated in status „F11 - forward“ refer to CV 130	0 - 255	0
210	Assignment of function button F12 Reverse A	Assignment of function outputs that are activated in status „F11 - reverse“ refer to CV 129	0 - 255	0

List of all supported CVs

CV	Name	Description	Range	Value
211	Assignment of function button F11 Reverse B	Assignment of function outputs that are activated in status „F11 - reverse“ refer to CV 130	0 - 255	0
213	Assignment of function button F12 Forward A	Assignment of function outputs that are activated in status „F12 - forward“ refer to CV 129	0 - 255	0
214	Assignment of function button F12 Forward B	Assignment of function outputs that are activated in status „F12 - forward“ refer to CV 130	0 - 255	0
216	Assignment of function button F12 Reverse A	Assignment of function outputs that are activated in status „F12 - reverse“ refer to CV 129	0 - 255	0
217	Assignment of function button F12 Reverse B	Assignment of function outputs that are activated in status „F12 - reverse“ refer to CV 130	0 - 255	0
219	Assignment of function button F13 Forward A	Assignment of function outputs that are activated in status „F13 - forward“ refer to CV 129	0 - 255	0
220	Assignment of function button F13 Forward B	Assignment of function outputs that are activated in status „F13 - forward“ refer to CV 130	0 - 255	0
222	Assignment of function button F13 Reverse A	Assignment of function outputs that are activated in status „F13 - reverse“ refer to CV 129	0 - 255	0
223	Assignment of function button F13 Reverse B	Assignment of function outputs that are activated in status „F13 - reverse“ refer to CV 130	0 - 255	0
225	Assignment of function button F14 Forward A	Assignment of function outputs that are activated in status „F14 - forward“ refer to CV 129	0 - 255	0
226	Assignment of function button F14 Forward B	Assignment of function outputs that are activated in status „F14 - forward“ refer to CV 130	0 - 255	0
228	Assignment of function button F14 Reverse A	Assignment of function outputs that are activated in status „F14 - reverse“ refer to CV 129	0 - 255	0
229	Assignment of function button F14 Reverse B	Assignment of function outputs that are activated in status „F14 - reverse“ refer to CV 130	0 - 255	0

CV	Name	Description	Range	Value
231	Assignment of function button F15 Forward A	Assignment of function outputs that are activated in status „F15 - forward“ refer to CV 129	0 - 255	0
232	Assignment of function button F15 Forward B	Assignment of function outputs that are activated in status „F15 - forward“ refer to CV 130	0 - 255	0
234	Assignment of function button F15 Reverse A	Assignment of function outputs that are activated in status „F15 - reverse“ refer to CV 129	0 - 255	0
235	Assignment of function button F15 Reverse B	Assignment of function outputs that are activated in status „F15 - reverse“ refer to CV 130	0 - 255	0
253	Start inhibitor	decelerates start for the time given. Enables synchronized start of locos with LokSound decoders (for tractions)	0 - 255	0
254	Constant stopping distance	A Value > 0 forces the stopping distance independent of speed being kept	0 - 64	0

List of all supported CVs (mfx-Decoder)

21.2. mfx-Decoder

Value settings, which can be reached via Motorola programming.



Important: All values have to be multiplied by „ 4“, if used together with a Central Station or the ESU LokProgrammer, as a value setting of 0 - 255 is adequate!!!

CV	Name	Description	Range	Value
01	Engine address	Address of engine	01 - 80	03
02	Starting voltage	determines the minimum speed	01 - 63	03
03	Acceleration	This value multiplied by 0.25 is the time from stop to maximum speed	01 - 63	16
04	Deceleration	This value multiplied by 0.25 is the time from maximum speed to stop	01 - 63	12
05	Maximum speed	Maximum speed of loco	01 - 63	63
08	Factory reset	Resets decoder to default values	-	8
53	Load control parameter 1 (control reference)	Determines the back EMF voltage that the motor should supply at maximum speed. The more efficient the motor, the higher this value may be. Reduce this value if the engine does not reach its designed maximum speed.	01 - 63	45
54	Load control Parameter 2	„K-component“ of the internal PI-controller. Determines how strongly load control effects. The higher the value, the stronger the decoder controls the motor.	01 - 63	32
55	Load control Parameter 3	„I-component“ of the internal PI-controller. The momentum of the motor determines parameter 3. Motors with large flywheels or large diameter require a smaller value.	01 - 63	24
56	Load control influence	0 – 100 % Determines how strongly load control is active.	01 - 63	63
78		Starting voltage in analogue mode AC	01 - 63	25
79		Maximum speed in analogue mode AC	01 - 63	63

For your personal notes:

Appendix

22. Appendix

22.1. How to program long addresses

As described in chapter 9.2., the long address is separated into two CVs. In CV17 you will find the higher-valued byte of the address. This byte determines the section, in which the address will lie. Is there, e.g., a value of 192 in CV17, the extended address can accept values between 0 and 255. Is there a value of 193 in CV17, the extended address can accept values between 256 and 511. This can be continued up to a value of 231 in CV17, then the extended address can take a value of 9984 and 10239. In fig. 18 all possible sections are listed. To calculate the values refer to the following:

- First determine the address desired, e.g. 4007.
- Refer to the values shown in fig. 19, and choose the address section concerned. In the right column next to the address section chosen you will find the numerical value you have to write in CV17, here our example for 207:

CV 18 is appraised as follows:

	address desired	4007
minus	first address found in address section -	3840
	=====	=====
equals	value of CV18	167

- Figure 167 is now the value you have to write in CV18, thus your decoder is responsive to address 4007.

If you wish to read out your addresses, please read out CV17 and CV18 one after another and flip the process:

Let's say you read out the following:

CV17 = 196; CV 18 = 147. For the corresponding address section look on fig. 19. The first possible address of this section is 1024. Now you have to add it to the value of CV18, and you will just know the address of the loco:

$$\begin{array}{r}
 1024 \\
 + \quad 147 \\
 \hline
 = 1473
 \end{array}$$

Address sections from to CV17			Address sections from to CV17			Addresses sections from to CV17		
0	255	192	3584	3839	206	7168	7423	220
256	511	193	3840	4095	207	7424	7679	221
512	767	194	4096	4351	208	7680	7935	222
768	1023	195	4352	4607	209	7936	8191	223
1024	1279	196	4608	4863	210	8192	8447	224
1280	1535	197	4864	5119	211	8448	8703	225
1536	1791	198	5120	5375	212	8704	8959	226
1792	2047	199	5376	5631	213	8960	9215	227
2048	2303	200	5632	5887	214	9216	9471	228
2304	2559	201	5888	6143	215	9472	9727	229
2560	2815	202	6144	6399	216	9728	9983	230
2816	3071	203	6400	6655	217	9984	10239	231
3072	3327	204	6656	6911	218			
3328	3583	205	6912	7167	219			

Figure 19: Scale of extended loco addresses!

23. Warranty

24 months warranty form date of purchase

Dear customer,

Congratulations on purchasing this ESU product. This quality product was manufactured applying the most advanced production methods and processes and was subjected to stringent quality checks and tests.

Therefore ESU electronic solutions ulm GmbH & Co. KG grants you a warranty for the purchase of ESU products that far exceeds the national warranty as governed by legislation in your country and beyond the warranty from your authorized ESU dealer.

ESU grants an extended manufacturer's warranty of 24 months from date of purchase.

Warranty conditions:

- This warranty is valid for all ESU products that have been purchased from an authorised dealer.
- No claims will be accepted without proof of purchase. The filled in warranty certificate together with your ESU dealer's receipt serves as proof of purchase. We recommend keeping the warranty certificate together with the receipt.
- In case of claim please fill in the enclosed fault description as detailed and precise as possible and return it with your faulty product.

Extend of warranty / exclusions:

This warranty covers free of charge repair or replacement of the faulty part, provided the failure is demonstrably due to faulty design, manufacturing, material or transport. Please use the appropriate postage stamps when shipping the decoder to ESU. Any further claims are excluded.

The warranty expires:

1. In case of wear and tear due to normal use
2. In case of conversions of ESU - products with parts not approved by the manufacturer.
3. In case of modifications of parts, particularly missing shrink sleeves, or wires directly extended on the decoder.
4. In case of inappropriate use (different to the intended use as specified by the manufacturer).
5. If the instructions as laid down in the user manual by ESU electronic solutions ulm GmbH & Co. KG were not adhere to.

Due to liability reasons any inspections or repairs can only be carried out on products that are not installed in a locomotive or carriage. Any locomotive sent to ESU for inspection will be returned without even touching it. There is no extension of the warranty period due to any repairs or replacements carried out by ESU.

You may submit your warranty claims either at your retailer or by shipping the product in question with the warranty certificate, the receipt of purchase and fault description directly to ESU electronic solutions ulm GmbH & Co. KG :

ESU GmbH & Co. KG
- Garantieabteilung -
Industriestraße 5
D-89081 Ulm



Trouble Shooting Sheet

1. Personal information











(Please use block letters)

Name: _____
Street: _____
.....
ZIP code/ city: | | | | | _____
Country: _____
Email: _____
Telephone: _____
Date: _____
Signature: _____

2. Product details and system environment

Art.No.: _____ Date of purchase: _____ Address : _____
Operation mode: AC Analog AC Digital DC Analog DC Digital (DCC)
Commandstation: ECoS Märklin® 6021 ROCO® Digital LGB® MZS Intellibox
 Lenz® Digital andere:

3. Error description

<input type="checkbox"/> headlight output front 	<input type="checkbox"/> no sound 	<input type="checkbox"/> wire harness 
<input type="checkbox"/> headlight output rear 	<input type="checkbox"/> wrong sound 	<input type="checkbox"/> change direction p 
<input type="checkbox"/> motor output 	<input type="checkbox"/> short circuit 	<input type="checkbox"/> without any function (DOA)
<input type="checkbox"/> programming 	<input type="checkbox"/> AUX outputs fail 	<input type="checkbox"/> Other problems: _____

4. Proof of purchase (please enclose this document!)

Please enclose your receipt / invoice. Otherwise no warranty possible!

5. Additional information:

6. Your retailer:

retailer's stamp or address

